

# OPTIMA 1328m

User manual



Thank you for purchasing this AgfaPhoto digital camera. Please read these operating instructions carefully in order to use the digital camera correctly. Keep the instructions in a safe place after reading so that you can refer to them later.

## Precautions

- Do not aim the camera directly into the sun or other intense light sources which could damage your eyesight.
- Do not try to open the case of the camera or attempt to modify this camera in any way. High-voltage internal components create the risk of electric shock when exposed. Maintenance and repairs should be carried out only by authorized service providers.
- Do not press the flash too close to the eyes of animals or young children. Eye damage may result. Please remain at least one meter away from infants when using flash.
- Keep the camera away from water and other liquids. Do not use the camera with wet hands. Never use the camera in the rain or snow. Moisture creates internal danger and may cause electric shock.
- Keep the camera and its accessories out of the reach of children and animals to prevent accidents or damage to the camera.
- If you notice smoke or a strange odor coming from the camera, turn the power off immediately. Take the camera to the nearest authorized service center for repair. Never attempt to repair the camera on your own.
- Use only the recommended power accessories. Use of power sources not expressly recommended for this equipment may lead to overheating, distortion of the equipment, fire, electrical shock or other hazards.

## Disclaimer

We assume no responsibility over and above the provisions of the Product Liability Law for damages suffered by the user or third parties as a result of inappropriate handling of the product or its accessories, or by their operational failure and by their use. We reserve the right to make changes to this product and its accessories without prior notice.

## Warning!

Never disconnect to open the camera or remove any parts of it. This will invalidate all guarantee claims.

# Contents

<b><u>GETTING STARTED</u></b>	<b>1</b>	TO ACTIVATE BLINK DETECTION	23
<b>USING THIS MENU</b>	<b>1</b>	USING THE Q MODE	24
<b>SCOPE OF DELIVERY</b>	<b>2</b>	SETTING IMAGE SIZE AND QUALITY	25
<b>PARTS OF THE CAMERA</b>	<b>3</b>	USING THE ZOOM FUNCTION	26
<b>INSERTING THE BATTERIES</b>	<b>5</b>	USING THE FLASH	27
LOW BATTERY INDICATOR	5	USING THE MACRO	28
<b>CHARGING THE BATTERY PACK</b>	<b>6</b>	USING THE SELF-TIMER & BURST	29
<b>INSERTING THE MEMORY CARD</b>	<b>7</b>	USING THE APERTURE PRIORITY	30
ABOUT CAMERA MEMORY	8	USING THE SHUTTER PRIORITY	30
DCF PROTOCOL	8	USING THE MANUAL EXPOSURE	31
<b>SETTING THE DISPLAY LANGUAGE / DATE &amp; TIME</b>	<b>8</b>	<b>RECORDING MOVIE CLIPS</b>	<b>32</b>
SETTING THE DISPLAY LANGUAGE	8	SETTING THE MOVIE SIZE	33
SETTING THE DATE & TIME	9	YOUTUBE® MODE	33
<b>USING THE LCD MONITOR</b>	<b>10</b>	<b>RECORDING AUDIO CLIPS</b>	<b>34</b>
REC MODE	10	PLAYING BACK AUDIO CLIPS	34
PLAYBACK MODE	11	<b>RECORDING A VOICE MEMO</b>	<b>35</b>
CHANGING THE LCD STATUS	12	PLAYING BACK A VOICE MEMO	35
<b><u>BASIC OPERATION</u></b>	<b>13</b>	<b><u>OTHER RECORDING FUNCTIONS</u></b>	<b>36</b>
<b>TURNING THE POWER ON AND OFF</b>	<b>13</b>	<b>SETTING THE METERING</b>	<b>36</b>
POWER SAVING FUNCTION	13	<b>SETTING THE WHITE BALANCE</b>	<b>36</b>
<b>CHANGING THE MODE</b>	<b>14</b>	<b>SETTING THE ISO</b>	<b>37</b>
SWITCHING BETWEEN REC MODE AND PLAYBACK MODE	14	<b>SETTING THE EXPOSURE</b>	<b>37</b>
SELECTING THE REC MODE	14	<b>SETTING THE AEB</b>	<b>37</b>
SELECTING THE ASM MODE	16	<b>SETTING THE HIGHLIGHT</b>	<b>37</b>
<b>USING THE MENUS</b>	<b>17</b>	<b>SETTING THE SHARPNESS</b>	<b>38</b>
REC MENU	17	<b>SETTING THE PHOTO EFFECT</b>	<b>38</b>
SETUP MENU	18	<b>SETTING DATE STAMP</b>	<b>38</b>
<b><u>BASIC RECORDING</u></b>	<b>21</b>	<b>SETTING STABILIZER</b>	<b>39</b>
<b>RECORDING STILL IMAGES</b>	<b>21</b>	<b>SETTING FACE TRACKING</b>	<b>39</b>
<b>USING SMILE CAPTURE MODE</b>	<b>22</b>	<b>SETTING PHOTO FRAME</b>	<b>39</b>
TO ACTIVATE SMILE CAPTURE	22	<b>SETTING AF LAMP</b>	<b>39</b>
<b>USING BLINK DETECTION MODE</b>	<b>23</b>	<b><u>PLAYBACK</u></b>	<b>40</b>
		<b>PLAYING BACK IMAGES</b>	<b>40</b>
		PLAYING BACK MOVIE CLIPS	40
		MAGNIFYING & TRIMMING STILL IMAGES	

	41	<b>USERS IN PRIVATE HOUSEHOLDS IN THE</b>	
VIEWING IN THUMBNAIL	42	<b>EUROPEAN UNION</b>	<b>68</b>
PLAYING A SLIDE SHOW	42	<b>FCC COMPLIANCE AND ADVISORY</b>	<b>68</b>
<b>DELETING FILES</b>	<b>43</b>		
DELETING A SINGLE FILE	43		
DELETING MULTIPLE FILES	44		
DELETING ALL FILES	45		
PROTECTING A SINGLE FILE	45		
PROTECTING ALL FILES	46		
PROTECTING MULTIPLE FILES	47		
<b>EDITING IMAGES</b>	<b>48</b>		
ROTATING STILL IMAGES	48		
CHANGING THE IMAGE SIZE	48		
CHANGING THE IMAGE WITH EFFECTS	49		
CHOOSING THE IMAGE WITH PHOTO			
FRAME	49		
<b>COPYING THE FILES</b>	<b>50</b>		
<b>SETTING THE DPOF</b>	<b>51</b>		
<b>CHOOSING A STARTUP IMAGE</b>	<b>52</b>		
<b><u>MAKING CONNECTIONS</u></b>	<b><u>53</u></b>		
<b>CONNECTING THE CAMERA TO A TV</b>	<b>53</b>		
<b>CONNECTING THE CAMERA TO A PC</b>	<b>54</b>		
USING THE CARD READER	54		
CONNECTING THE CAMERA TO A			
COMPUTER WITH THE USB CABLE	54		
<b><u>APPENDIX</u></b>	<b><u>55</u></b>		
<b>ABOUT THE FOLDER &amp; FILE NAME</b>	<b>55</b>		
FOLDER STRUCTURE	55		
FILE NAMING	56		
<b>TROUBLESHOOTING</b>	<b>57</b>		
<b>SPECIFICATIONS</b>	<b>58</b>		
<b>FUNCTION AVAILABLE LIST</b>	<b>60</b>		
<b>CUSTOMER CARE</b>	<b>67</b>		
<b>COPYRIGHT</b>	<b>68</b>		
<b>TRADEMARK RECOGNITION</b>	<b>68</b>		
<b>DISPOSAL OF WASTE EQUIPMENT BY</b>			



# Getting Started

## Using This Menu

### Getting Started

This section contains information you should know before using this camera.

### Basic Operation

This section explains all recording features of this camera.

### Basic Recording

This section explains how to record still images, movies, and audio files.

### Other Recording Functions

This section explains common operations about recording images.

### Playback

This section explains playback, delete, and edit functions of still images, movies and audio files.



### Making Connections

This section tells you how to connect this camera to a computer or TV.

### Appendix

This section describes the troubleshooting and the camera specification.

The meanings of the symbols used in this user's manual are explained below:

 <b>Caution</b>	This indicates cautions that should be read before using these functions.
 <b>Tips</b>	This indicates the useful information when using this camera.
	This indicates the reference page.

## Contents

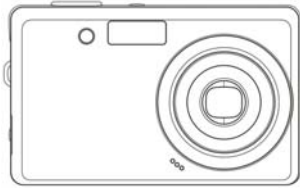

AgfaPhoto  
OPTIMA 1328m

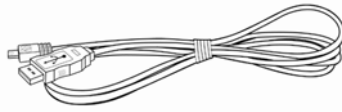

USB Cable

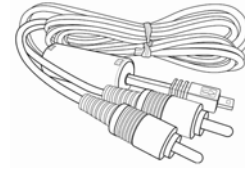

AV Cable

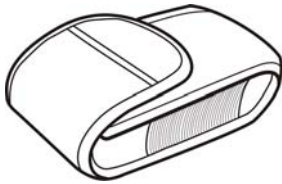

Soft Case



Strap

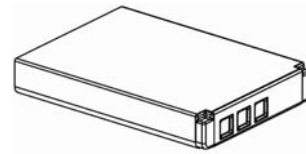

Rechargeable  
Lithium-ion Battery

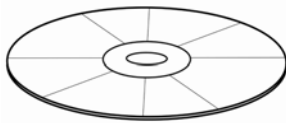

Software Installation  
CD-ROM

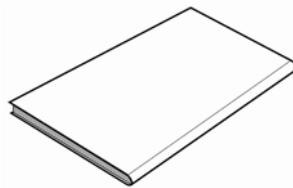

Quick Start Guide

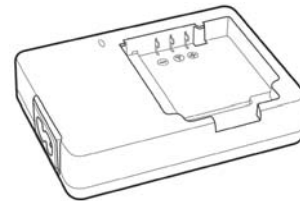

Battery Charger

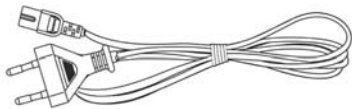

Adaptor

### Caution

---

- Actual accessories may be different.
- Note that the shape of the charger plug depends on the area where you purchased the camera.
- Do not swing the camera around by the strap.

## Parts of the Camera

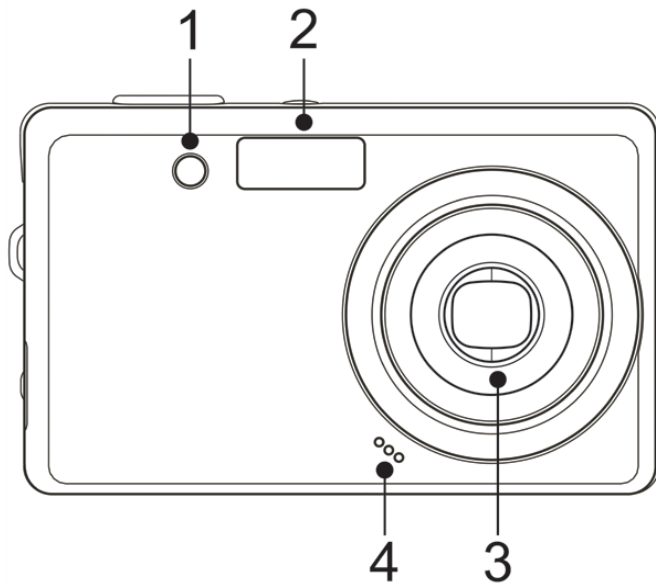

- 1. AF Lamp / Self-timer Lamp
- 2. Flash (👉 page 27)
- 3. Lens
- 4. Microphone

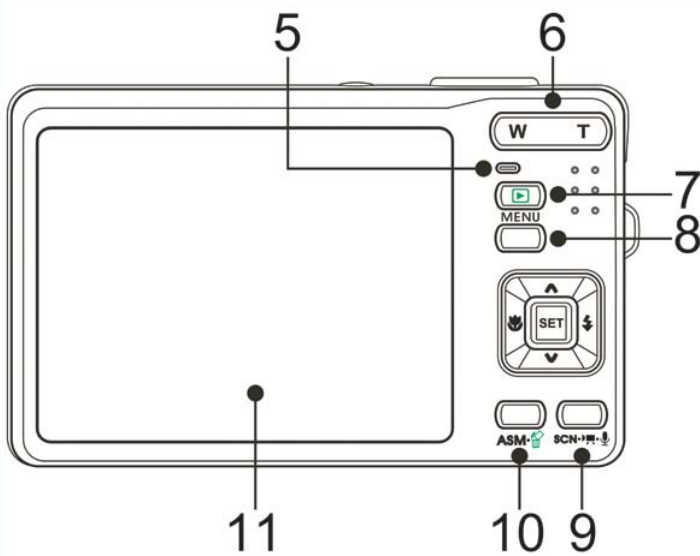

- 5. Operation Lamp
- 6. Zoom Button (👉 page 26)
  - Thumbnail (👉 page 42)
  - Playback Zoom (👉 page 41)
- 7. Playback Button (👉 page 14)
- 8. Menu Button (👉 page 17)
- 9. Mode Button (👉 page 14)
- 10. ASM Button (👉 page 16)
  - Delete Button (👉 page 43)
- 11. LCD Monitor (👉 page 10)
- 12. Flash Button (👉 page 27)
- 13. SET/DISP Button (👉 page 12)
- 14. Macro Button (👉 page 28)

### Four-way Control

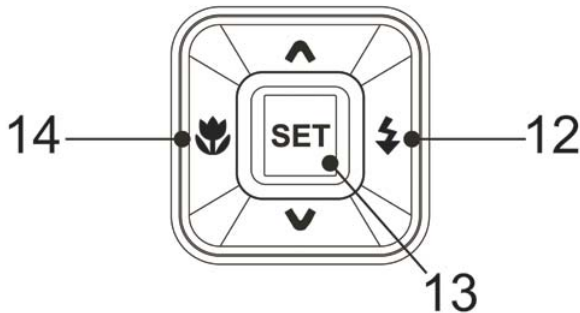



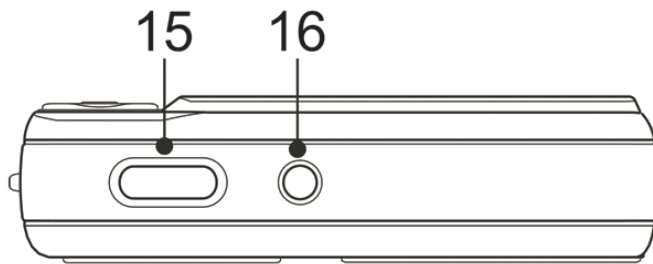

- 15. Shutter Button  
(☞ page 21, 32)
- 16. Power Button (☞ page 13)

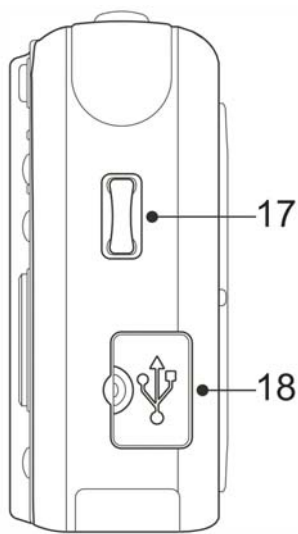

- 17. Strap Ring
- 18. USB/AV Terminal  
(☞ page 20, 54)

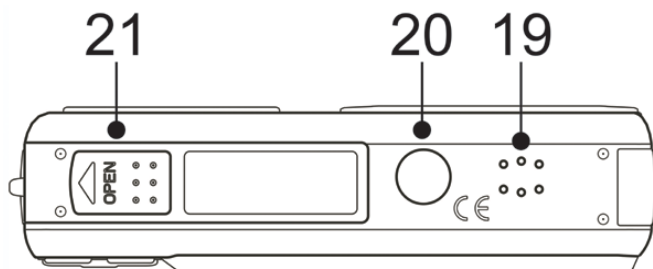

- 19. Speaker
- 20. Tripod Socket
- 21. Battery Cover (☞ page 5)

## Inserting the Batteries

The camera is powered by a rechargeable lithium-ion battery (Li-Ion 820 mAh).

- 1** .....  
**Open the battery cover.**
- Slide the battery cover in the direction indicated by the arrow.

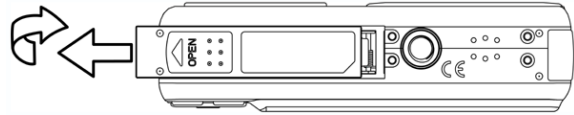

- 2** .....  
**Insert the batteries.**
- Install the battery with the terminal facing inside the camera.

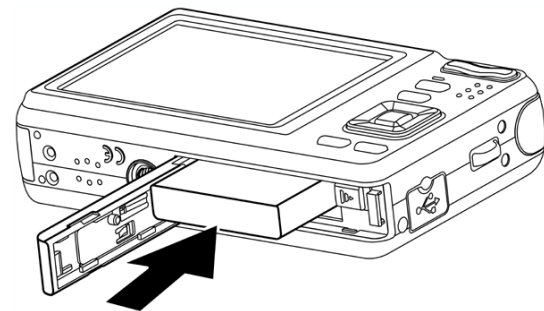

- 3** .....  
**Close the battery cover.**

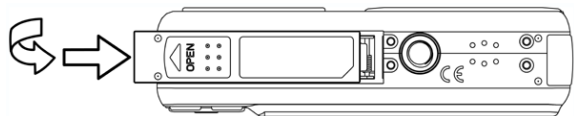

### Low Battery Indicator

A low battery indicator  appears on the LCD screen when the batteries are nearly exhausted. Batteries should be replaced promptly when the low battery indicator appears.

## Charging the Battery Pack

The battery is not charged when you purchase the camera. You need to charge the battery before using the camera

**1** .....  
**Place the battery pack in the charger with the label facing up.**

**2** .....  
**Connect the AC adaptor to the charger, and then plug it into a power outlet.**

- The charger lamp lights red and battery charging begins. When charging is completed, the lamp becomes green.

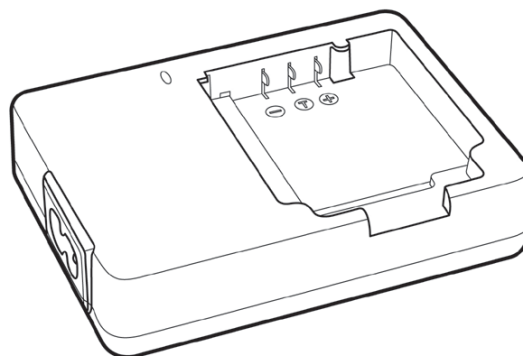

### **Caution**

- Risk of explosion if battery is replaced by an incorrect type dispose of used batteries according to the instructions.
- Be sure to turn off the camera power before insert or remove batteries.
- Remove batteries if you will not be using them for a long time.
- The camera body may feel warm after extended use. This is normal.
- Use only the special rechargeable lithium-ion battery to power this camera.
- Charging time is varying with current battery capacity and charging conditions.

## Inserting the Memory Card

You can use SD/SDHC Card with this digital camera. The memory card slot is located beneath the battery cover, adjacent to the battery compartment.

**1** .....  
**Open the battery cover.**

- Slide the battery cover in the direction indicated by the arrow.

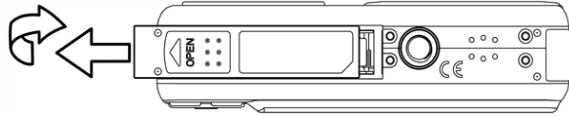

**2** .....  
**Insert the card.**

- Insert the card with the label facing up and the arrow pointing in.

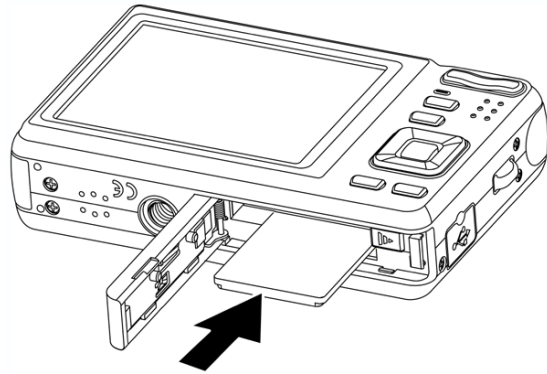

**? Tips**

- To remove the card, gently press on the edge of the card and release it. Pull the card out and close the battery cover.

**3** .....  
**Close the battery cover.**

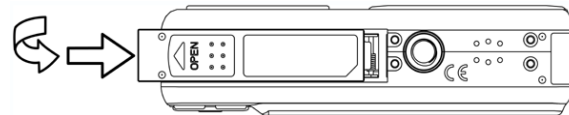

**! Caution**

- It may cause damage to the card if removed while the camera is on.
- Do not touch the connection terminals on the back side of the card.
- Not all cards may be compatible with your camera. When purchasing a card, please check the card's specifications and take the camera with you

## About Camera Memory

This camera is equipped with internal memory. If the memory card is not inserted in the camera, all images and movie clips recorded by the camera will be stored in the internal memory. If the memory card is inserted, images and movie clips are stored on the memory card.

## DCF Protocol

The DCF protocol defines the format for image file data as well as the directory structure for the memory card. Images that are taken by a DCF camera can be viewed on DCF-compatible cameras from other manufacturers.

## Setting the Display Language / Date & Time

When using the camera for the first time after purchasing, be sure to choose a language and set the date & time before using the camera.

### Setting the Display Language

- 1** Turn the power on, and set the camera to the Setup Menu (page 18).
- 2** Select [Language].
  - Press ▲ or ▼ to select [LANGUAGE] then press ► or the SET button to launch the submenu.
- 3** Select a language.
  - Press ▲ or ▼ to select a language and press ◀ or the SET button to apply the setting.
- 4** Press the MENU button to close the menu.



## Setting the Date & Time

**1** Turn the power on, and set the camera to the **Setup Menu** (☞ page 18).

**2** Select [🗓️ **Date & Time**].

- Press ▲ or ▼ to select [Date & Time] then press ▶ or the **SET** button to launch the submenu.

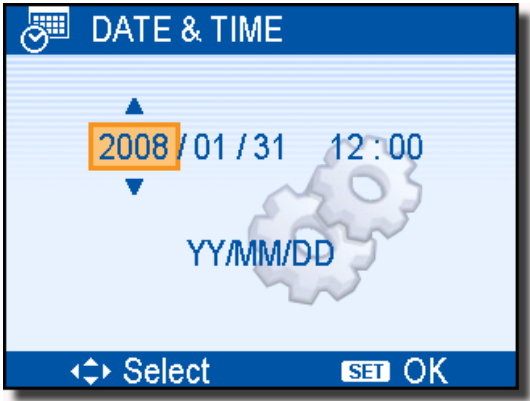

**3** Set date and time.

- Press ▲ or ▼ to change the value of the cursor located. Press ◀ or ▶ to move the cursor between settings.

**? Tips**

- Holding down ▲ or ▼ changes the values continuously.
- For date stamp setting (☞ page 38).

**4** Apply the setting.

- After adjusting the settings, press the **SET** or the **MENU** button to apply the setting.

**! Caution**

- If the batteries are removed for longer than 48 hours, the Date and Time will need to be re-set.

## Using the LCD Monitor

The LCD monitor is used to compose images while recording, adjust settings and replay images. The following indicators may appear on the LCD monitor while recording or playing back images.

### REC mode

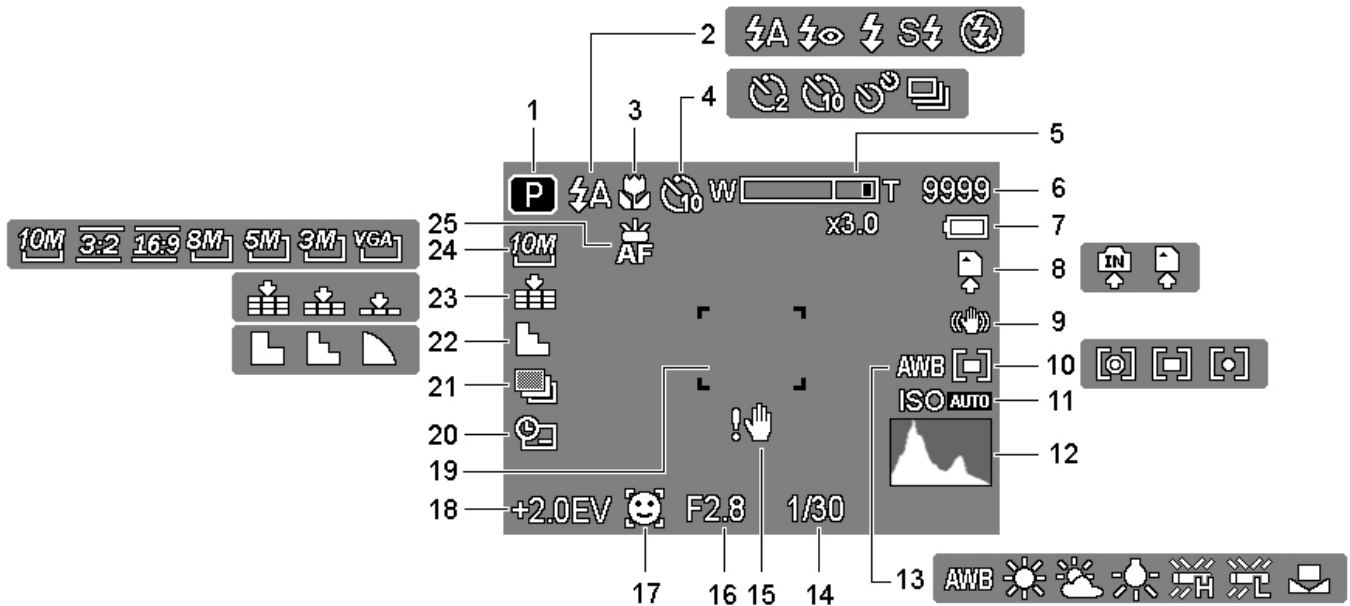

- |    |                                |    |                            |
|----|--------------------------------|----|----------------------------|
| 1  | Recording mode (👉 page 14)     | 14 | Shutter speed (👉 page 21)  |
| 2  | Flash (👉 page 27)              | 15 | Shake warning (👉 page 21)  |
| 3  | Macro (👉 page 28)              | 16 | Aperture value (👉 page 21) |
| 4  | Self-timer / Burst (👉 page 29) | 17 | Face tracking (👉 page 39)  |
| 5  | Zoom indicator (👉 page 26)     | 18 | Exposure (👉 page 37)       |
| 6  | Shots remaining                | 19 | Focus area (👉 page 21)     |
| 7  | Battery (👉 page 5)             | 20 | Date stamp (👉 page 38)     |
| 8  | Storage media                  | 21 | AEB (👉 page 37)            |
| 9  | Stabilizer                     | 22 | Sharpness (👉 page 38)      |
| 10 | Metering (👉 page 36)           | 23 | Quality (👉 page 25)        |
| 11 | ISO (👉 page 37)                | 24 | Resolution (👉 page 25)     |
| 12 | Histogram                      | 25 | AF Lamp (👉 page 39)        |
| 13 | White balance (👉 page 36)      |    |                            |

PLAYBACK mode

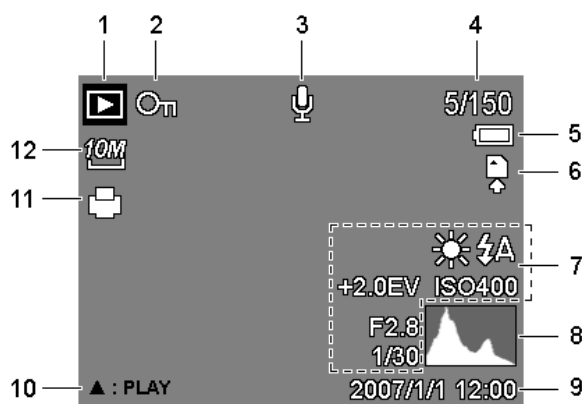

- |                             |                                   |
|-----------------------------|-----------------------------------|
| 1 Playback mode (👉 page 14) | 7 Recording info (👉 page 12)      |
| 2 Protect (👉 page 45)       | 8 Histogram                       |
| 3 Voice memo (👉 page 35)    | 9 Captured date & time            |
| 4 File number / Total       | 10 Voice memo control (👉 page 35) |
| 5 Battery (👉 page 5)        | 11 DPOF (👉 page 51)               |
| 6 Storage media             | 12 Resolution (👉 page 25)         |

**!** Caution

- Some information may not display correctly if you display images captured by other camera model.



## Changing the LCD Status

Press the **SET/DISP** button changes the LCD status as shown below:

### ■ REC mode

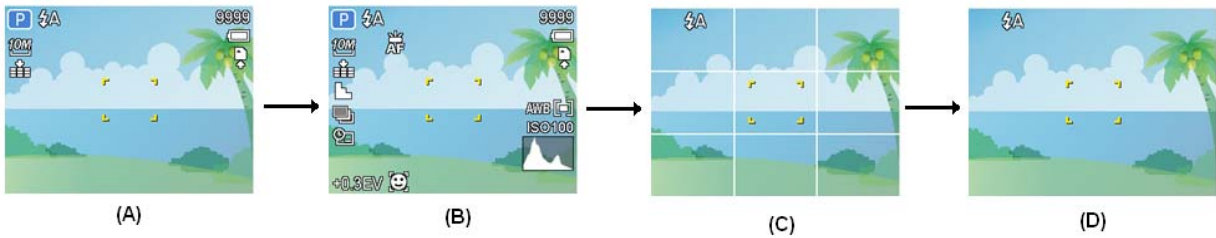

(A) OSD on

(B) Full OSD

(C) Guide line

(D) OSD off



### Tips

- Use the “Guide line” to compose images easily before shooting images.

### ■ PLAYBACK mode

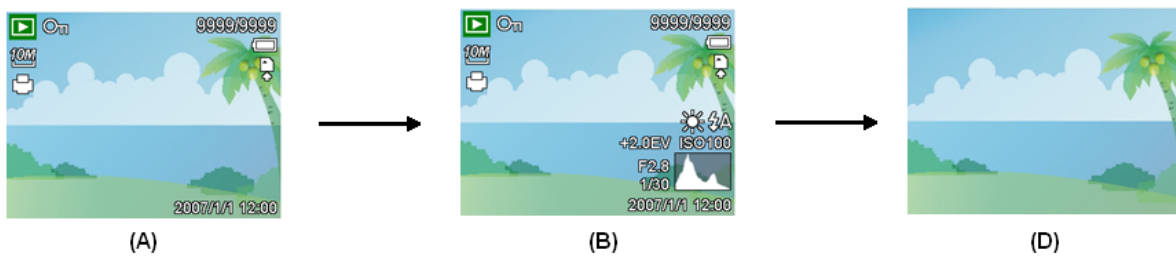

(A) OSD on

(B) Full OSD

(D) OSD off



### Caution

- You cannot change the LCD status in the following situation:
  - Manual exposure
  - Recording movie clips or audio files
  - Playing movie clips or audio files
  - Playing the slideshow
  - Viewing in thumbnail
  - Trimming a still image

# Basic Operation

## Turning the Power On and Off

- 1** Press the **POWER** button (❶) to turn on the camera in the **REC** mode.
- The power turns on, the lens extends and the LED lights in green.

- Press the **PLAYBACK** button (❷) to turn on the camera in the **PLAYBACK** mode.
- The power turns on, and an image displays on the LCD monitor (❸).

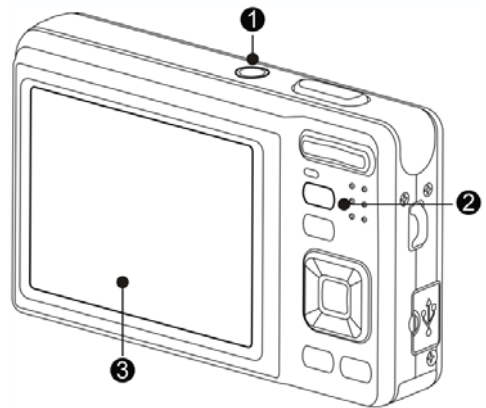

- 2** Press the **POWER** button (❶) again to turn the power off.
- The power turns off, the lens retracts and the LED turns off.

- ? Tips**
- You can turn on the camera without the start-up and operating sound by pressing and holding the **POWER** (❶) or the **PLAYBACK** (❷) button over 1.5 seconds.
  - Switch between REC mode and PLAYBACK mode (☞ page 14).

## Power Saving Function

For saving the battery power, the LCD monitor automatically turns off 1 minute after the last control accessed (factory-preset setting). Press any button other than the power button to turn on the LCD monitor. You can change the power save setting in Setup menu (☞ page 19).

After the power saving function has been active for 1 minute, the power will turn off completely. Press the **POWER** (❶) or the **PLAYBACK** (❷) button to restore the power.

The power save feature will not activate in the following situation:

- Recording movie clips or audio files
- Playing movie clips or audio files

- Playing the slideshow
- Connecting the camera to a computer or printer with the USB cable

## Changing the Mode

You can record images and voices in the REC mode. And using the PLAYBACK mode to replay, delete, or edit images on the LCD monitor.

### Switching between REC mode and PLAYBACK mode

In REC mode, press the **PLAYBACK** button (❶) to switch to the PLAY mode.

In PLAY mode, press the **PLAYBACK** (❶) or the **MODE** (❷) button to switch to the REC mode.

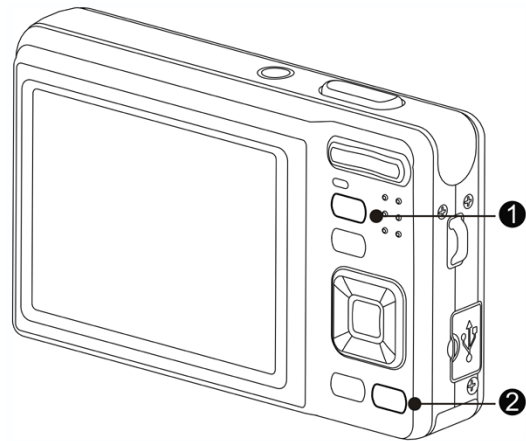





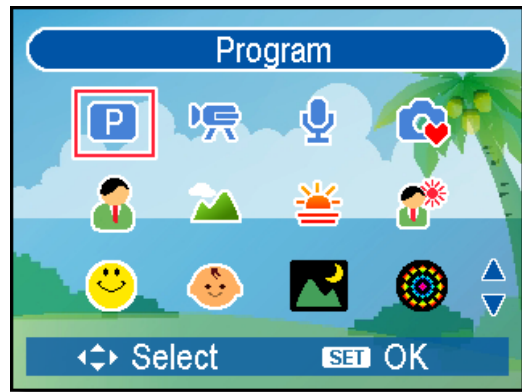















### Selecting the REC mode

- 1** .....  
**Set the camera to the REC mode** (👉 page 14).
- 2** .....  
**Launch the mode palette.**
  - Press the **MODE** button (❷) to show the scene mode palette.
- 3** .....  
**Select a mode.**
  - Use the four-way control to select a desired mode and press the **SET** button to confirm the setting.



Display	Title	Description
	Program	The camera makes settings suitable for the shooting conditions.
	Movie	For recording movie clips.
	Voice REC	For recording audio.

Display	Title	Description
	Q Mode	Allows beginners to take pictures easily.
	Portrait	Blurring the background to focus on the subject.
	Landscape	Used for the wide scenic views.
	Sunset	Enhance the red hue for recording sunset images.
	Backlight	Shooting the image of backlight object by changing metering.
	Smile Capture	Capture the most brilliant smile of characters.
	Kids	Take a still image to capture moving kids.
	Night Scene	Shooting the subject while keeping the background night scenery.
	Fireworks	Slow shutter speed to take fireworks exploding.
	Snow	Used for the beach or snow scenes.
	Sports	Used to take still pictures in high speed motions.
	Party	Used for the wedding or indoor parties.
	Candlelight	To capture the warmth effects of candle light.
	Night Portrait	Use to take portrait pictures when the background is darker.
	Soft Skin	Enhance the tone of skin so that the facial skin appears smooth.
	Soft Flowing Water	Can take pictures with effects as smooth as silk.
	Food	Higher saturation makes food more appetizing.
	Building	Enhance the edges of the subject.
	Text	Enhance the black & white contrast.
	Auction	Records small-size images that are perfect for auction notices.
	Blink Detection	This feature detects if the subject blinked an eye when the image is captured and gives the user an option whether to save it or not.

## Selecting the ASM mode

1

### Set the camera to the REC mode

(👉 page 14).

- It cannot be switch to ASM mode while in Movie or Voice REC mode.

2

### Launch the ASM mode.

- Press the **ASM** button (❶) to toggle switch between Aperture Priority, Shutter Priority, Manual Exposure mode.
- For detail operation (👉 page26).

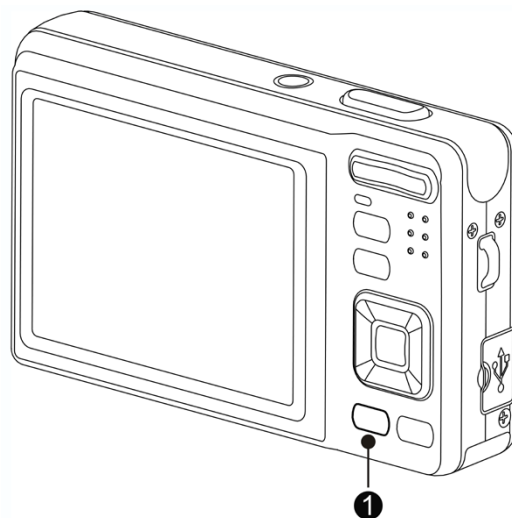

3

### Exit the ASM mode.

- Use the ASM jog wheel or the display mode button select the scene then a recording mode. (👉 page 30).

## Using the Menus

When a menu is displayed, the four-way control and the **SET** button are used to make the desired settings.

### REC menu

**1** Turn the power on, and set the camera to the REC mode (page 14).

**2** Open the REC menu.

- Press the **MENU** button (1) to display the menu.

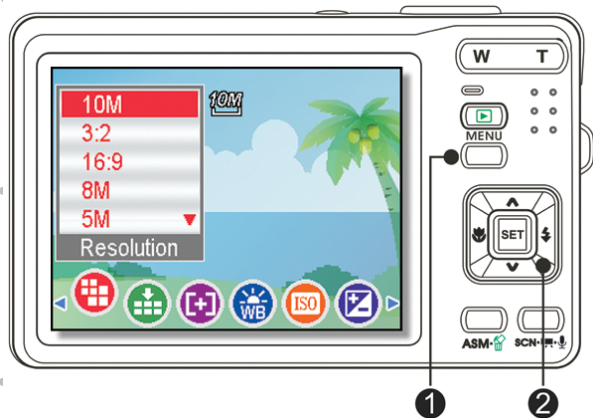

**3** Select an item.

- Press ◀ or ▶ (2) to select a menu item.

**4** Change the setting.

- Press ▲ or ▼ (2) to change the setting.

**5** Press the **MENU** (1) or the **SET** (2) button to save the settings and close the menu.

### REC menu list (Still Image)

Menu Item	Available Setting	Page
Resolution	10M / 3:2 / 16:9 / 8M / 5M / 3M / VGA	25
Quality	High / Medium / Low	25
Metering	Spot / Center / Multi	36
White Balance	Auto / Daylight / Cloudy / Shade / Fluorescent / Incandescent / Custom	36
ISO	Auto / ISO100 / ISO200 / ISO400 / ISO800 / ISO1600 / ISO3200	37
Exposure	-2.0EV ... +2.0EV	37
Drive Mode	Off / 2 / 10 / ∞ / Self-timer	29
AEB	Off / On	37
Highlight	Off / On / Off	37
Sharpness	Low / Medium / High	38

Effect	Off / B&W / Sepia / Negative / Red / Green / Blue	38
Date Stamp	Off / Date / Date & Time	38
Digital Zoom	Off / On	26
Stabilizer	Off / On	39
Face Tracking	Off / On	39
Photo Frame	Off / Frame 1 ~ 10	39
AF Lamp	Auto / Off	39

**REC menu list (Movie)**

Menu Item	Available Setting	Page
Movie Size	16:9 / 640 / 320 / [Icon]	33
Metering	[Icon] / [Icon] / [Icon]	36
White Balance	Auto / [Icon] / [Icon] / [Icon] / [Icon] / [Icon] / [Icon]	36

**Setup menu**

**1** Turn the power on, and set the camera to the REC or PLAYBACK mode (page 14).

**2** Press the MENU button (1) to open the REC or PLAYBACK menu.

- The menu displays depends on whether you are in the REC mode or the PLAYBACK mode.

**3** Open the Setup menu.

- Press four-way control (2) to select **SETUP** ( [Icon] ) and then press the **SET** ( [Icon] ) button to display the Setup menu.

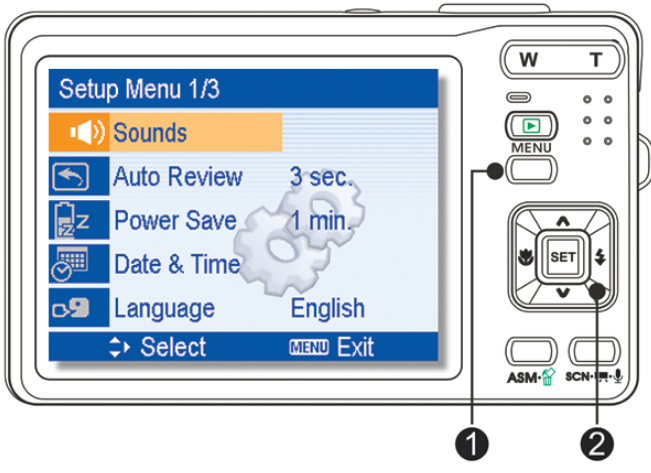

- 4** .....  
**Select an item.**
- Press ▲ or ▼(Ⓢ) to select a menu item and then press ► or the **SET** (Ⓢ) button to launch the submenu.

- 5** .....  
**Change the setting.**
- Press ▲ or ▼ (Ⓢ) to select an option and press ◀ or the **SET** (Ⓢ) button to apply the setting.

- 6** .....  
**Press the MENU (Ⓢ) button to close the menu.**

**Setup menu list**

Menu Item	Functions
Sounds	<p><b>[Shutter]:</b> Sets the shutter sound on and off.</p> <p><b>[Start-up]:</b> Sets a type of the start-up sound.</p> <p><b>[Beep]:</b> Sets the operation sound on and off.</p> <p><b>[Volume]:</b> Adjusts the volume of the shutter sound, start-up sound, beep and playback sound.</p>
Auto Review	<p><b>[Off]:</b> The captured image will not automatically display after shooting.</p> <p><b>[1 sec.]:</b> The captured image will display for 1 second after shooting.</p> <p><b>[3 sec.]</b> The captured image will display for 3 seconds after shooting.</p> <p><b>[5 sec.]:</b> The captured image will display for 5 seconds after shooting.</p>
Power Save	<p><b>[Off] / [1 min.] / [3 min.] / [5 min.]:</b>                      For power consumption, the camera is turned off automatically for a period of time.</p> <ul style="list-style-type: none"> <li>• The power save feature will not activate in some situation (☞ page 13).</li> </ul>
Date & Time	Sets the date & time (☞ page 9).
Language	Select a language for display menus and other information from the following 21 languages: (☞ page 8)



Menu Item	Functions
File No.	Use this function if the camera experiences a “Folder cannot be created” error or if you want to restart numbering, for example, after erasing all files.
	<p><b>[Series]:</b> Store the latest used file number no matter deleting files or inserting a new memory card.</p> <p><b>[Reset]:</b> Reset file numbering each time the memory card is changed.</p>
	<ul style="list-style-type: none"> <li>Resetting the file number is useful for avoiding the file name duplication when images are downloaded to a computer (👉 page 55).</li> </ul>
TV Out	<p>You can review images on a television with a supplied AV cable (👉 page 53). TV Out should be set to either NTSC or PAL depending on your region.</p> <p><b>[NTSC]:</b> America, Japan and others</p> <p><b>[PAL]:</b> Europe, Oceania and others</p>
USB	<p><b>[Computer] / [Printer]:</b></p> <p>Sets the USB mode to connect the camera with a printer or computer (👉 page 54).</p>
S.Image	Sets a recorded image as the start-up image (👉 page 52).
Format	<p>To erase all data stored in the memory card if you are using a card, or all data stored in the internal memory if there is no card inserted.</p> <ul style="list-style-type: none"> <li>A “BUSY...PLEASE WAIT” message displays and the memory card is starting format.</li> <li>A “COMPLETED” message displays when finish formatting.</li> <li>All data will be deleted including protected files. Be sure to download important files to your computer before formatting.</li> </ul>
LCD Save	<p><b>[Off / On]:</b></p> <p>Enable the LCD save function to automatically decrease the LCD brightness to conserve battery power</p> <p>When the camera is idle for 5 seconds, the LCD darkens.</p>
Reset All	<p>Resets the entire menu and button operation settings to initial default.</p> <p>The following settings do not change after Reset All:</p> <ul style="list-style-type: none"> <li>Date &amp; Time setting</li> <li>Language setting</li> <li>TV out setting</li> </ul>

# Basic Recording

## Recording Still Images

**1** Turn the power on, and set the camera to the REC mode (page 14).

**2** Compose the subject on the monitor.

- Aim the focus area (1) to the subject that you want to take.

**3** Half press the shutter button to focus the image.

- The focus area (1) becomes green while in focus, then shutter speed (2), aperture value (3) and ISO value (4) are displayed.
- If the shutter speed is slow or the possibility that image may be blurred, the shake warning icon !👉 may appear on the LCD monitor. To avoid this, use a tripod to stabilize the camera when recording images.

**4** Take a picture.

- Press the shutter button fully to take a picture.

**! Caution**

- Make sure that your fingers or the wrist strap does not block the lens.

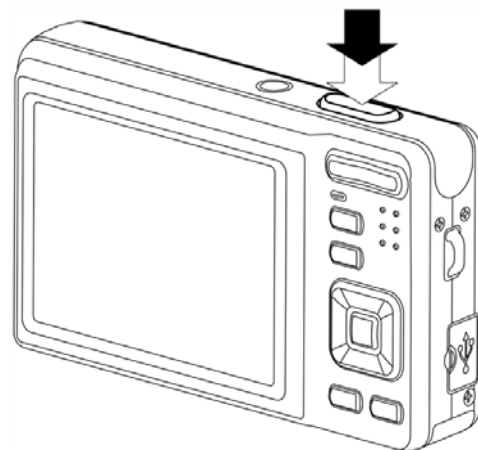
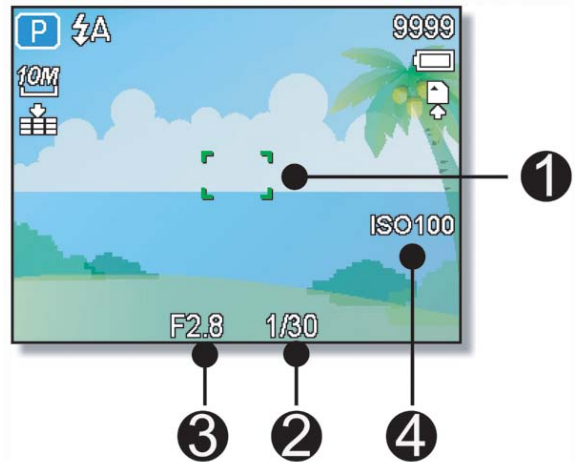

## Using Smile Capture Mode

The smile capture model uses smile tracking to automatically capture images. Pressing the shutter button will enable the camera to take 6 continuous shots whenever a smile is detected. This feature is most useful in capturing different angles and smiles of moving people. When capturing an image with more than one person, the camera detects the smile of the closest person on the center of the screen

### To activate Smile Capture

**1** .....  
Select  from Scene Mode submenu. (👉 page 14).

**2** .....  
Focus the camera on the subject to capture.

**3** .....  
Press the shutter button to start smile detecting. The smile capture icon blinks every second and the white focus frame turns green to denote camera activity.

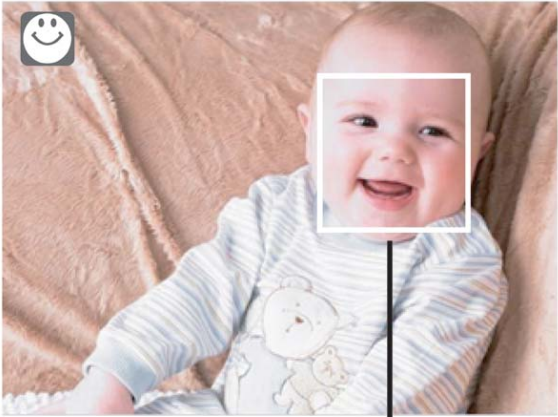

Camera displays a white tracking frame when smile is detected

**4** .....  
When a smile is detected, the camera will automatically take a shot of the image. It will continuously take 6 shots whenever a smile is detected.

**5** .....  
To stop shooting before the 6 shots are taken, press the shutter button again, The smile capture icon stops blinking and the focus frame turns white.

### Tips

- When capturing an image with several faces, face tracking function may take up more time tracking faces for the first time.

## Using Blink Detection Mode

The Blink Detection mode tracks faces and determines captured image that contain subjects with blinked eyes. After shooting, when the camera detects that the subject blinked an eye, a menu selection appears to ask the user whether to save the image or not. This feature saves time in managing photos to be stored or deleted from the memory.

### To activate Blink Detection

**1** .....

Select  from Scene Mode submenu. (👉 page 14).

**2** .....

Half press the shutter button to focus the subject. The frame turns green to indicate focus is set.

**3** .....

Press the shutter button to capture the image. The image is automatically saved unless the camera detects that the subject blinked an eye.

**4** .....

Select Save Image to save or Cancel to disregard.

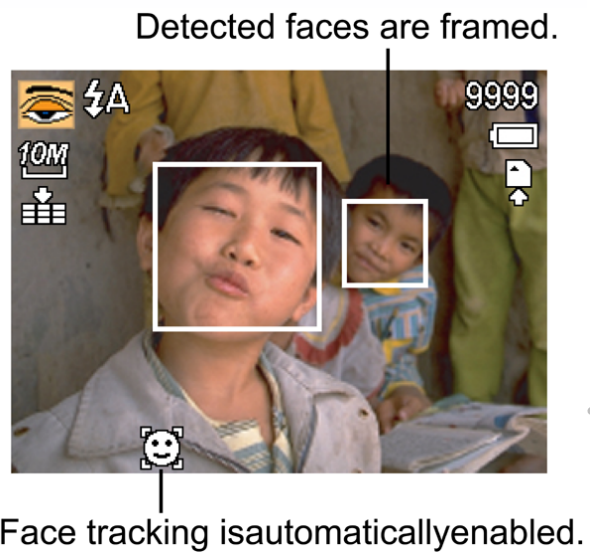

## Using the Q mode

The Q mode provides a simplified camera interface. Larger icons and fewer controls make it easier to take pictures anytime, especially for the beginners and elder users.

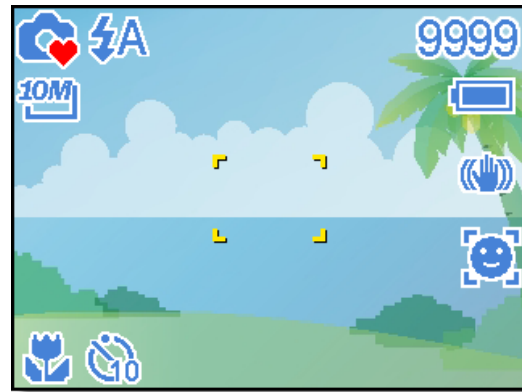

You can use only the basic settings in the Q mode:

Button	<b>Flash:</b> Auto / Red eye / Force on / Slow sync / Force off
	<b>Macro:</b> Off / On
	<b>SET/DISP:</b> OSD on / Guide line / OSD off
Menu	<b>Resolution:</b> 10M / 3:2 / 16:9 / 8M / 5M / 3M / VGA
	<b>Drive Mode:</b> Off / 2 sec. / 10 sec. / Double / Burst
	<b>Stabilizer:</b> Off / On
	<b>Face Tracking:</b> Off / On
	<b>Photo Frame:</b> 10 frames can be selected
	<b>Beep:</b> Off / On
	<b>Auto Review:</b> Off / 1 sec. / 3 sec. / 5 sec.

Rest of settings will not be controlled as below:

Fixed setting (*)	<ul style="list-style-type: none"> <li>Quality: S.Fine</li> <li>Metering: Multi</li> <li>White balance: Auto</li> <li>ISO: Auto</li> <li>Exposure: Auto</li> <li>AEB: Off</li> <li>Highlight: Off</li> <li>Sharpness: Normal</li> <li>Effect: Off</li> <li>Date Stamp: Date &amp; Time</li> <li>Digital Zoom: Off</li> <li>AF lamp: Auto</li> </ul>
Utility setting (**)	<ul style="list-style-type: none"> <li>Shutter sound</li> <li>Start-up sound</li> <li>Power save</li> <li>Date &amp; Time</li> <li>Language</li> <li>File No.</li> <li>TV out</li> <li>USB</li> <li>Start-up image</li> </ul>

(\*)Fixed setting: Settings are fixed in Q mode.

(\*\*)Utility setting: Use the same setting as last mode used.



## Setting Image Size and Quality

You can select lower image resolution and quality to decrease the image size to capture more images. Choose a suitable setting according to the desired image quality and purpose. For details, see page 17.

### Resolution Values

Image Size		Print Size	
<b>10M</b>	3648 x 2736	Printing larger than A4-size.	Larger ↑ ↓ Smaller
<b>3:2</b>	3648 x 2432		
<b>16:9</b>	3648 x 2048		
<b>8M</b>	3264 x 2448		
<b>5M</b>	2560 x 1920		
<b>3M</b>	2048 x 1536	Printing to postcards or attaching to e-mail.	
<b>VGA</b>	640 x 480		

### Quality Values

Compression		Purpose	
	Super Fine	Shoot higher quality images.	Higher Quality ↑ ↓ Lower Quality
	Fine	Shoot normal quality images.	
	Normal	Shoot for more images.	

## Using the Zoom Function

Your camera has a combination of optical and digital zoom functions that allows you to zoom in on far away subjects or zoom out for a wide angle shot.

The optical zoom is achieved by mechanically adjusting the lens of the camera. The digital zoom enlarges or shrinks the image using a software process.

**1** .....  
**Select the zoom setting, and point the camera at the subject.**

**2** .....  
**Press the zoom button (1) to compose the image.**

[W]: zoom out for a wide-angle shot.

[T]: zoom in for a telephoto shot.

- When the zoom button is pressed, the zoom bar appears on the LCD monitor.
- When the optical zoom (2) factor is at maximum, zooming stops temporarily. Press the [T] again, the camera switches to the digital zoom (3) automatically and zooming continues.
- The digital zoom (3) will not activate in movie recording.

**3** .....  
**Press shutter button to take a picture.**

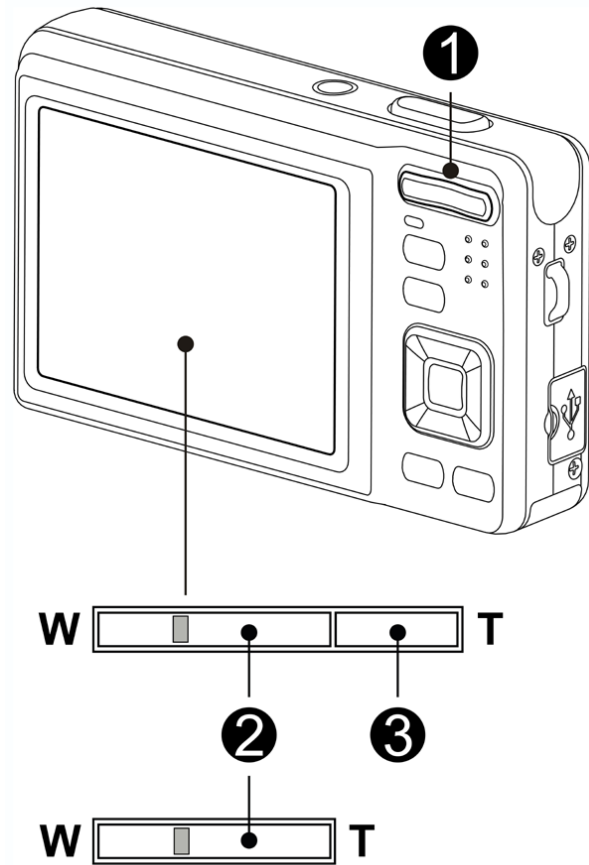

### ? Tips

- Digital zoom works by enlarging the center portion of an image through a software interpolation process.
- The digital zoom is used to achieve magnification levels up to approx. 4 times.

## Using the Flash

The flash is not only for taking pictures when there is insufficient light, but also when the subject is in shade or in backlight conditions. Press the flash button to cycle your camera through the various flash modes. The flash will not activate when continuous shooting or movie recording.

**1** Turn the power on, and set the camera to the REC mode (👉 page 14).

**2** Press the flash button (❶) to change the flash mode.

- Each time the flash button is pressed, the flash icon (❷) changes.

**⚡A** Auto flash:

Flash fires automatically when shooting conditions require extra lighting.

**⚡👁** Red-eye reduction:

Flash strobos to let the subject's eyes adjust to the flash, then fires again to take the actual image. Your camera will detect the subject brightness and use the flash only when required.

**⚡** Force on:

Flash fires every time you take a photo, regardless of lighting conditions.

**S⚡** Slow sync:

Flash fires with a slow shutter speed.

**⚡🚫** Force off:

The flash never fires even in dark situation.



**3** Press shutter button to take a picture.

### ! Caution

- The flash charging time may increase when the battery is low.
- The available flash settings are limited depending on the REC mode you selected (👉 page 60).



## Using the Macro

Your camera is equipped with a macro function that allows you to focus on very close subjects. In macro mode you can focus on subjects 15 cm from the lens when in the maximum wide angle setting and 40 cm in the maximum telephoto setting.

**1** .....  
**Turn the power on, and set the camera to the REC mode**  
(☞ page 14).

**2** .....  
**Press the macro button (🌸) enters the macro mode.**

- The macro icon (🌸) displays in the LCD monitor.
- To leave the macro mode, press the macro button (🌸) again.

**PF Pan Focus:**

When Pan Focus is set, the camera focuses on every object.

**INF Infinity:**

When Infinity is set, the camera focuses on distant objects.

**3** .....  
**Press shutter button to take a picture.**

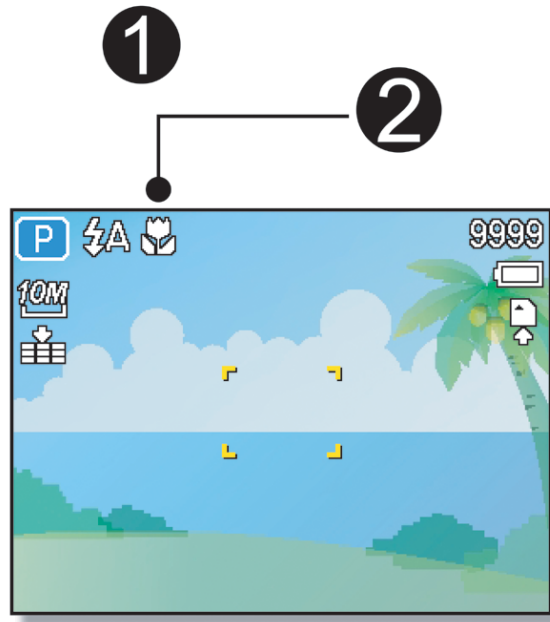
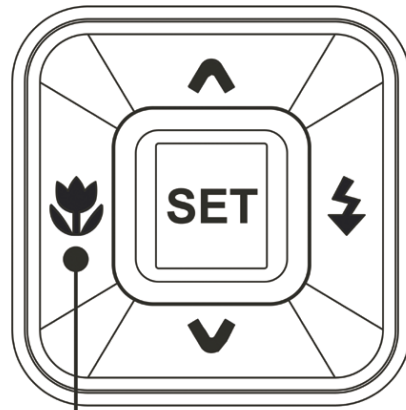

**Tips**

- Distances referred to measure the distance between the camera lens surface and the subject.
- The available macro settings are limited depending on the REC mode you selected. (☞ page 60).

## Using the Self-timer & Burst

Use the self-timer to set a delay from the time the shutter button is pressed to the time the image is shot. Use the burst to record continuous still images shooting.

**1** Turn the power on, and set the camera to the REC mode (page 14).

**2** Open the REC menu (page 17).

- Use ◀ or ▶ to select [Drive mode] from the REC menu.

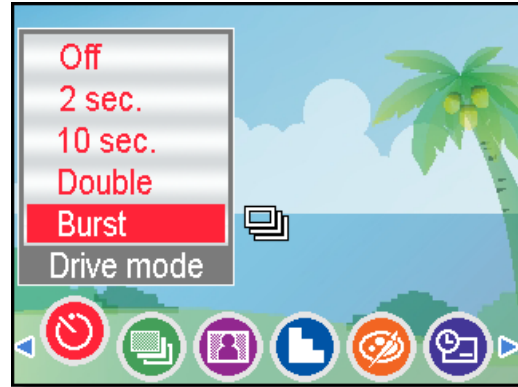



**3** Change the setting.

- Press ▲ or ▼ to select a drive mode, then press the SET button.

**Off:**  
Record a single image.

 **2 sec.:**  
The shutter release will be delay for 2 seconds.

 **10 sec.:**  
The shutter release will be delay for 10 seconds.

 **Double:**  
Record two images in a shot after pressing the shutter release button 10 and 12 seconds.

 **Burst:**  
Keep pressing the shutter button fully to take continuous shooting.  
Release the shutter button to stop shooting.

**4** Press shutter button to take a picture.



### Tips

- When using the self-timer function, be sure to use a tripod or place the digital camera on a level, stable surface.

## Using the Aperture Priority

In this mode, you can set an aperture value to match the brightness. A higher aperture value brings the background out of focus. Selecting a lower aperture value allows you to soften the background.

**1** Turn the power on, and set the camera to the Aperture Priority (☞ page 16).

**2** Adjust the aperture value by pressing ▲ or ▼ button.

**3** Press shutter button to take a picture.

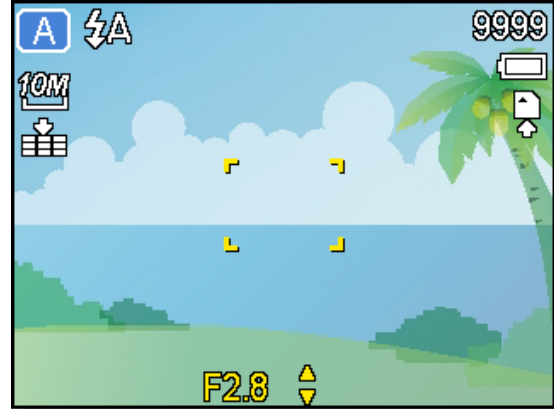

### ? Tips

- The larger the aperture value the smaller the lens opening, allowing less light to enter the camera.

## Using the Shutter Priority

In this mode, you can set a shutter speed to match the brightness. Faster shutter speeds allow you to take a sharp picture of a moving subject while slower speeds create a trail effect and allow you to shoot without a flash in dark areas.

**1** Turn the power on, and set the camera to the Shutter Priority (☞ page 16).

**2** Adjust the shutter speed by pressing ▲ or ▼ button.

**3** Press shutter button to take a picture.

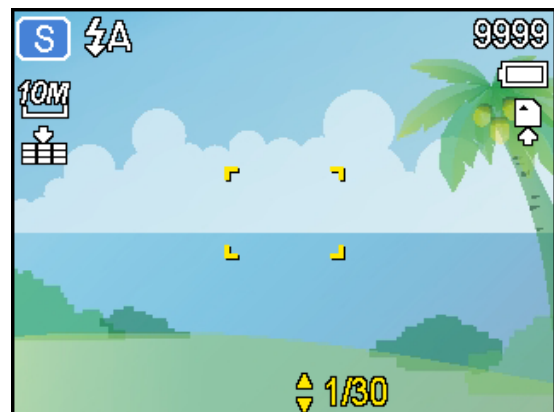

## Using the Manual Exposure

You can manually set the shutter speed and aperture to achieve a particular effect.

**1**

Turn the power on, and set the camera to the Manual Exposure (page 16).

**2**

Use the SET button to switch between aperture value and shutter speed control. Press ▲ or ▼ to adjust the setting.

**3**

Press shutter button to take a picture.

- Press the shutter button halfway, the difference between the standard exposure and the selected exposure appears in red.



## Recording Movie Clips

**1** Turn the power on, and set the camera to the Movie mode (👉 page 14).

**2** Compose the subject on the monitor.

- Aim the focus area (④) to the subject that you want to take.
- The LCD monitor displays the available recording time (⌚).

**3** Start recording.

- Press the shutter button (①) to start recording.
- Using the zoom button (②) to adjust the image size.
- The White Balance is set and locked to the settings of the first frame

**4** Finish recording.

- Press the shutter again to end recording.
- The camera will stop recording automatically when the memory capacity has been reached.

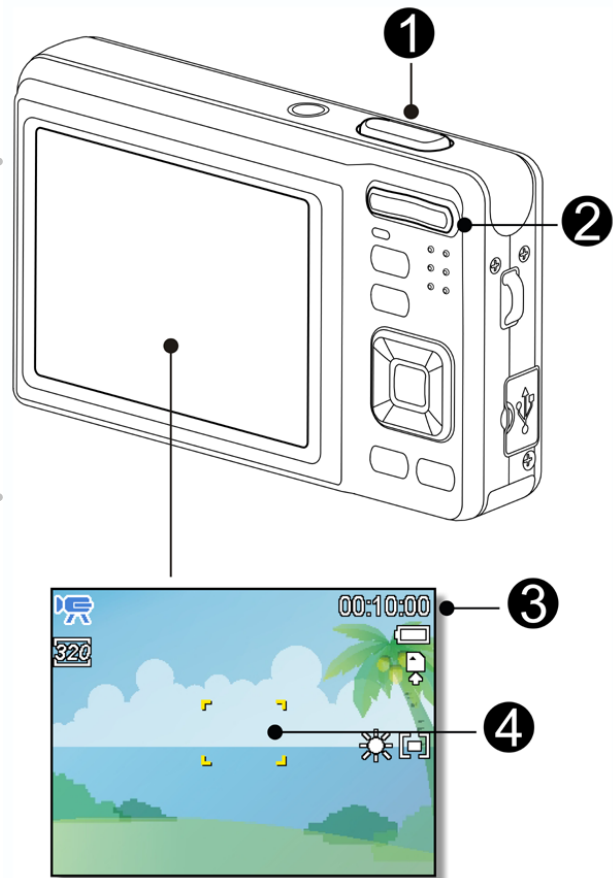





**! Caution**

- Sound cannot be recorded while pressing the zoom button..
- The digital zoom cannot be used in Movie mode.
- When the maximum capacity for a single video has been reached, simply press the shutter button again to continue recording. The camera will automatically stop recording when the memory capacity is full.

## Setting the Movie Size

### Movie Size and Image Quality

Icon	Resolution	Frame Rate
	720 x 400	30 frames/sec.
	640 x 480	
	320 x 240	
	640 x 480 (YouTube®)	

## YouTube® Mode

The YouTube Mode allows you to record movies with predefined video settings for easy upload to the YouTube® website.

### 1 ..... YouTube® supports two file upload standards:

- Single File Uploader. The maximum movie file size is up to 100 MB.
- YouTube® Uploader. The maximum movie file size is up to 1 GB.

Most uploaded movie length ranges within 5 minutes, although you can upload a maximum movie length of 10 minutes.

### 2 ..... Therefore when you record using the YouTube® mode, the following standards are followed:

- Recorded movies are set to YouTube® standard resolution of 640 x 480.
- Recording automatically stops when the file reaches 100 MB.

### ? Tips )-----●

- If internal memory/memory card is full or the file exceeds 2G in size, the video recording will automatically stop.
- To record a YouTube® movie, select  from the Movie Size function.

## Recording Audio Clips

1

Turn the power on, and set the camera to the Voice REC mode (👉 page 14).

2

Press the shutter button to start recording.

- The voices are recorded from the microphone of the camera. Be careful to avoid touching the microphone while recording.

3

Press the shutter button again to end recording.

- The camera will stop recording automatically when the memory capacity has been reached.

## Playing Back Audio Clips

1

Turn the power on, and set the camera to the PLAYBACK mode (👉 page 14).

2

Press ◀ or ▶ to select the audio clip that you want to playback.

3

Start playing back.

- Press ▲ to start playing the audio clip.
- Press ▼ to stop the audio clip, or press ▲ to pause it. When audio clip paused, press ▲ again to resume.



## Recording a Voice Memo

You can add a voice memo to the still images after you record it.

**1** Turn the power on, and set the camera to the **PLAYBACK** mode (☞ page 14).

**2** Press ◀ or ▶ to select a still image that you want to add a voice memo to.

- If the image already has the voice memo recorded, the  appears on the LCD monitor. The new recording will replace the previous one.

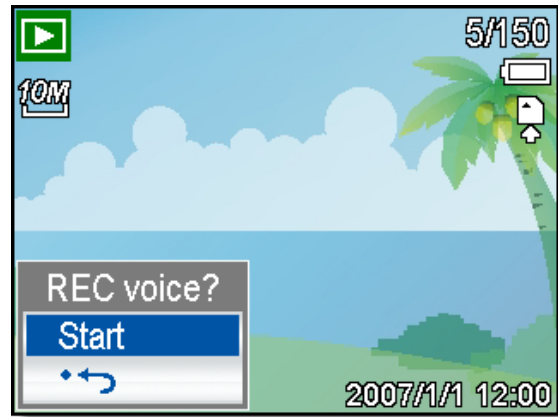

**3** Open the **PLAYBACK** menu.

- Press the **MENU** button, using four-way control to select **Voice Memo** () and press the **SET** button.

**4** Press the **SET** button to start recording for 30 seconds.

- Press the **SET** button again to end recording.

### ! Caution

- The voice memo cannot be added to a movie clip or a protected image.
- You cannot delete only the voice memo. When you delete the image, the attached voice memo is also deleted.

## Playing Back a Voice Memo

**1** Turn the power on, and set the camera to the **PLAY** mode (☞ page 14).

**2** Press ◀ or ▶ to select the image that has the voice memo recorded.

**3** Start playing back.

- Press ▲ to start playing the voice memo.





- Press ▼ to stop the voice memo, or press ▲ to pause it. When voice memo paused, press ▲ again to resume.

## Other Recording Functions





### Setting the Metering

There are 3 different light metering options available on your camera.

Option	Description
	Light is measured from the entire shooting screen, but gives more importance to the values near the center.
	Selects an exposure based on readings from multiple points in the subject area.
	Selects an exposure based on a single reading taken from the center of your picture.

### Setting the White Balance

Adjust the white balance to match different light sources such as sunlight, incandescent (tungsten) lighting or, fluorescent lighting.

Option	Description
<b>AUTO</b>	Automatically corrects white balance. Ideal for general photography.
	Adjusts for bright sun conditions, or natural light conditions.
	Adjusts for cloudy days or twilight conditions.
	Adjusts for normal indoor lighting conditions. Corrects the orange hue of household light bulbs. Ideal for indoor photos under tungsten or halogen lighting without a flash.
	Adjusts for fluorescent lighting. Corrects the green hue of fluorescent lighting. Ideal for indoor photos under fluorescent lighting without a flash.
	For more accurate adjustment or when the light source cannot be specified.

#### ? Tips

- Point the camera at a white piece of paper or similar object under the lighting

conditions for which you want to set the white balance, and then press the Shutter button.

## Setting the ISO

With the initial settings, the ISO sensitivity is automatically set according to the brightness of the subject.

Option	Description
Auto	Sets the ISO sensitivity automatically.
ISO 100	Sets the sensitivity to ISO 100 equivalent.
ISO 200	Sets the sensitivity to ISO 200 equivalent.
ISO 400	Sets the sensitivity to ISO 400 equivalent.
ISO 800	Sets the sensitivity to ISO 800 equivalent.
ISO 1600	Sets the sensitivity to ISO 1600 equivalent.
ISO 3200	Sets the sensitivity to ISO 3200 equivalent. (available only for 3M resolution or lower)



### Tips

- Higher ISO speeds increase the image noise. To take clean images, use as low an ISO speed as possible.



## Setting the Exposure

Set the exposure value manually to compensate for unusual lighting conditions such as indirect indoor lighting, dark backgrounds, and strong backlighting.

## Setting the AEB

Sets the auto exposure bracketing (AEB) to shoot 3 continuous images, each with a different exposure setting: correctly exposed, underexposed, and overexposed.

## Setting the Highlight



Make the subject stand out from its surroundings. The subject will be in focus in three different ranges:  /  / 

**?** **Tips**

- The Photo Frame and Face Tracking cannot be used as when using the Highlight.

## Setting the Sharpness

You can select whether you want the image to have sharp or soft outlines.

Option	Description
	The edges of the image are emphasized. The edges will become sharp, but noise may occur in the recording image.
	The edges of the image are sharp. This is suitable for printing.
	The edges of the image are softened. This is suitable for editing images on PC.

## Setting the Photo Effect

You can add special effects to your images in Record mode or in Playback mode.

Option	Description
Off	No effect is added to the image.
	Red eye removal. (Playback only)
B&W	Convert image to black & white.
Sepia	Recorded image will be stored in a sepia tone.
Negative	Opposite what they were in the original image.
Mosaic	Add mosaic tiles to the images. (Playback only)
Red	The image becomes reddish.
Green	The image becomes greenish.
Blue	The image becomes bluish.

## Setting Date Stamp

The Date Stamp function can be used to add a date to your pictures as you take them.

Option	Description
Off	Do not add the recorded date & time to printed images.
Date	Only add the recorded date to printed images.
Date & Time	Add the recorded date & time to printed images.

## Setting Stabilizer

When using higher sensitivity and faster shutter speed settings this function helps prevent image blur; caused by hand shake or target movement. This function allows good pictures to be taken with little effort.

## Setting Face tracking

After initializing the face tracking function, the lens will lock the main character in the picture and follow their movements. Also, the use of auto digital zoom technology allows the lens to extend and retract.



### Tips

- Pressing the shutter halfway showing green AF area means focus is complete.
- Face tracking is powered by Arcsoft.
- Under some environmental influences, face tracking function may be limited.
- The Highlight and Photo Frame cannot be used as using the Face Tracking.
- When capturing an image with several faces, face tracking function will take up more time tracking faces for the first time.

## Setting Photo Frame

You can add 10 kinds of frames to still images, making them more interesting.



### Tips

- This feature is only available with still images (except 3:2 and 16:9).
- The Highlight and Face Tracking cannot be used as using the Photo Frame.

## Setting AF Lamp

The AF Lamp function allows you record images in low light conditions.

Option	Description
Off	Disable the AF lamp while recording images.
Auto	The AF lamp turns on automatically by half pressing the shutter button under low light conditions.

# Playback

## Playing Back Images

- 1** Turn the power on, and set the camera to the **PLAYBACK** mode (☞ page 14).
  - The latest recorded image appears on the LCD monitor.
  - If there are no images stored, a message **[No image]** appears.

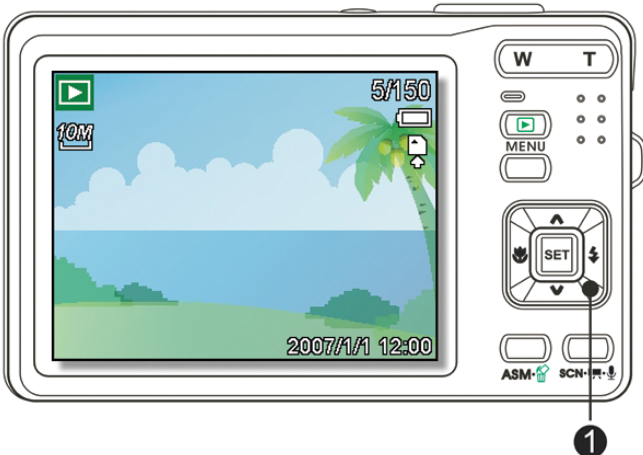

- 2** Press the four-way control ◀ or ▶ (⓪).
  - ◀: displays the previous image.
  - ▶: displays the next image.

**? Tips**

- Holding down ◀ or ▶ scrolls images in a high speed.

## Playing Back Movie Clips

- 1** Turn the power on, and set the camera to the **PLAYBACK** mode (☞ page 14).
- 2** Press ◀ or ▶ to select a movie clip that you want to playback.
- 3** Start playing back.
  - Press ▲ to start playing the movie clip.
  - Press ▼ to stop the movie clip, or press ▲ to pause it. When the movie paused, press ▲ again to resume.

**? Tips**

- During movie playing back, press ▶ to fast forward or press ◀ to rewind it.
- Press the shutter to capture the still image from the movie clip while it had paused.

## Magnifying & Trimming Still Images

**1** .....  
**Turn the power on, and set the camera to the PLAYBACK mode** (👉 page 14).

**2** .....  
**Select an image.**

- Press ◀ or ▶ (Ⓢ) to select the image that you want to magnify or trimming.
- Only still images can be magnified and trimmed.

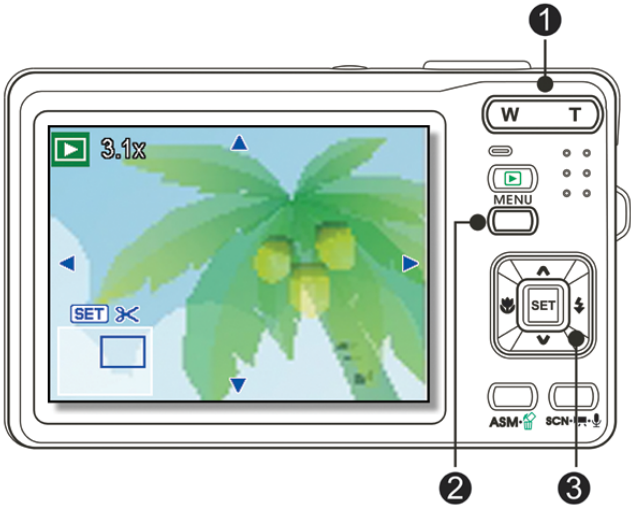

**3** .....  
**Magnify the image.**

- Press [T] (1) to magnify the image and the central portion of the image is displayed. You can use the arrow button (Ⓢ) to view different parts of the magnified image.
- Press the **MENU** button (2) to return to the normal size.

**4** .....  
**Trim the image.**

- Press the **SET** button (3) to set the image trimming.

**5** .....  
**Save the image.**

- Press the **SET** button (3) again to trim the selected image and save it as a new one.

## Viewing in Thumbnail

- 1 .....  
 Turn the power on, and set the camera to the **PLAYBACK** mode (☞ page 14).
- 2 .....  
 Press the zoom button [W], a thumbnail screen is displayed.
- 3 .....  
 Use the four-way control to select the desired image, and press [T] or the **SET** button to show the selected image in full screen.



### ? Tips

- You can protect or delete multiple images in thumbnail, see page 44, 47.

## Playing a Slide Show

- 1 .....  
 Turn the power on, and set the camera to the **PLAYBACK** mode (☞ page 14).
- 2 .....  
 Enter the slide show.
  - Press the **MENU** button (❶), use the four-way control (❷) to select **Slide Show** (🎞️) and press the **SET** button (❸).
- 3 .....  
 Change the slide show settings.
  - Use the four-way control (❷) to set the slideshow interval (🕒), effect (🎨) and repeat (🔄).
  - You can set the interval between 1~10 seconds.
- 4 .....  
 Playing the slide show.
  - Press the **SET** button (❸) to start the slideshow.
  - During the slideshow, press the **SET** button (❸) to pause the slideshow and press the **SET** button again to resume.

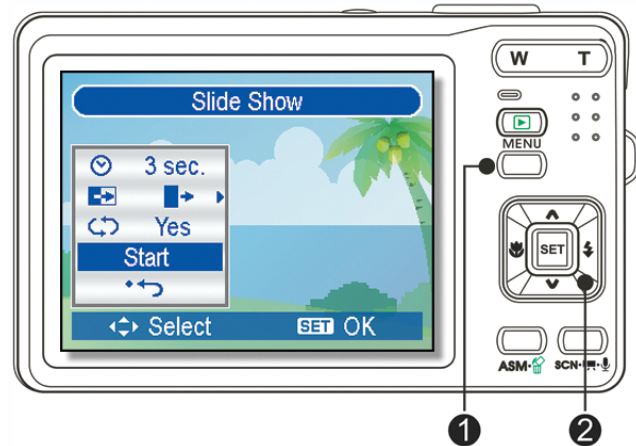

## Deleting Files

### Deleting a Single File

**1** Turn the power on, and set the camera to the **PLAYBACK** mode (☞ page 14).

**2** Open the menu.

- Press the **MENU** button (❶), then use the four-way control (❷) to select **Delete** (🗑️) and press the **SET** button (❸).

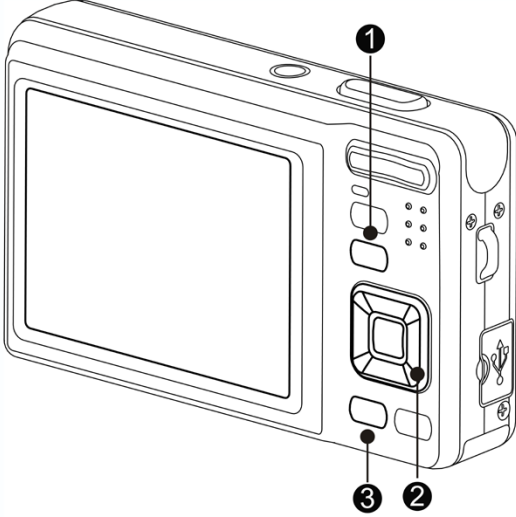

**3** Press ▲ or ▼ (❷) to select **[SINGLE]**, and then press the **SET** button (❸).

**4** Press ◀ or ▶ (❷) to select the image you want to delete.

**5** Press the **SET** button (❸) to delete the image.

- Repeat step 4~5 to delete images.

### ? Tips

- To quickly delete the current display image
  1. Select the image you want to delete.
  2. Press the **Delete** button (❸) to show a confirmation.
  3. Press the **SET** button (❷) to delete the current display image.
- Protected images cannot be deleted with this function.



## Deleting Multiple Files

**1** .....  
Turn the power on, and set the camera to the thumbnail screen (☞ page 42).

**2** .....  
Open the menu.  
• Press the **MENU** button, then Press ◀ or ▶ to select to select **Delete** (🗑️) and press the **SET** button.



**3** .....  
Press ▲ or ▼ to select [Select], and then press the **SET** button.  
• The frame of the selected image turns green.

**4** .....  
Select multiple images.  
• Use the four-way control to select the image.  
• Press the **SET** button toggles the 🗑️ on and off. Repeat this step until all images that you want to delete are displayed with an icon 🗑️.

**5** .....  
Delete images.  
• Press the **MENU** button, then select [Yes] and press the **SET** button. All selected images will be deleted.  
• To cancel delete, press the **MENU** button in this step.

## Deleting All Files

**1** Turn the power on, and set the camera to the **PLAYBACK** mode (☞ page 14).

**2** Open the menu.

- Press the **MENU** button, then use the four-way control to select **Delete** (🗑️) and press the **SET** button.

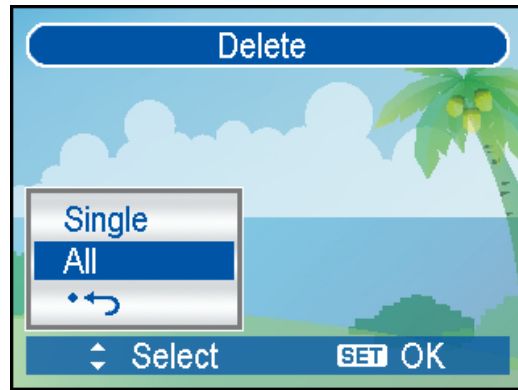

**3** Press ▲ or ▼ to select **[ALL]**, and then press the **SET** button.

**4** Press the **SET** button to delete all unprotected images.

## Protecting a Single File

**1** Turn the power on, and set the camera to the **PLAYBACK** mode (☞ page 14).

**2** Open the menu.

- Press the **MENU** button, then use the four-way control to select **Protect** (🔒) and press the **SET** button.

**3** Press ▲ or ▼ to select **[SINGLE]**, and then press the **SET** button.

**4** Press ◀ or ▶ to select the image you want to protect.

**5** Press the **SET** button to protect the image.

- When the file is locked, the 🔒 displays on the LCD monitor.
- Repeat step 4~5 to protect images.
- To unlock the file, press the **SET** button again in step 5. The 🔒 will disappear and the file is unlocked.

## Protecting All Files

**1** .....  
Turn the power on, and set the camera to the **PLAYBACK** mode (☞ page 14).

**2** .....  
Open the menu.

- Press the **MENU** button, then use the four-way control to select **Protect** (ⓘ) and press the **SET** button.
- You can open the menu in full screen or in thumbnail.

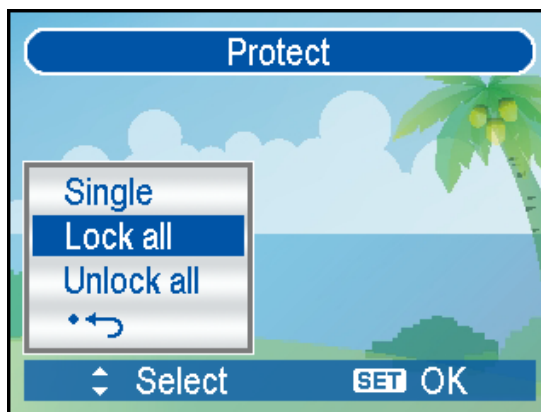

**3** .....  
Press ▲ or ▼ to select [**Lock all**], and then press the **SET** button.

- To unlock all files, select [**Unlock all**] in this step, then press the **SET** button.

**4** .....  
Press the **SET** button to protect all images.

## Protecting Multiple Files

**1** .....  
**Turn the power on, and set the camera to the thumbnail screen (👉 page 42).**

**2** .....  
**Open the menu.**

- Press the **MENU** button, then Press ◀ or ▶ to select to select **Protect** (⊙Π) and press the **SET** button.



**3** .....  
**Press ▲ or ▼ to select [Select], and then press the SET button.**

- The frame of the selected image turns green.

**4** .....  
**Select multiple images.**

- Use the four-way control to select the image.
- Press the **SET** button toggles the ⊙Π on and off. Repeat this step until all images that you want to protect are displayed with an icon ⊙Π.

**5** .....  
**Protect images.**

- Press the **MENU** button, then select **[Yes]** and press the **SET** button. All selected images will be protected.
- To cancel protect, press the **MENU** button in this step.

## Editing Images

### Rotating Still Images

**1** .....  
Turn the power on, and set the camera to the **PLAYBACK** mode (☞ page 14).

**2** .....  
Press ◀ or ▶ to select the image you want to rotate.

**3** .....  
Open the menu.  
• Press the **MENU** button, then use the four-way control to select **Rotate** (☞) and press the **SET** button.

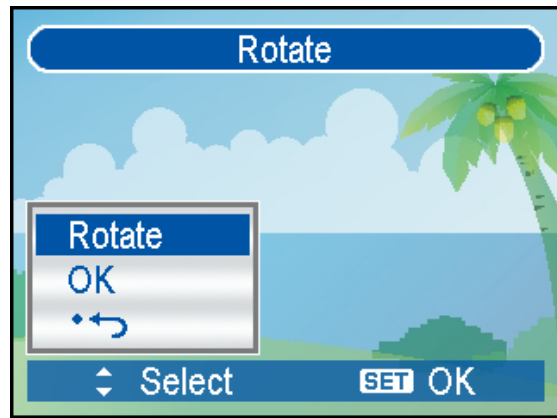

**4** .....  
Press the **SET** button to rotate the image.  
• Each press rotates the image 90 degrees in clockwise.

**5** .....  
Press ▲ or ▼ to select **OK**, and then press the **SET** button to finish rotating.

### Changing the Image Size

**1** .....  
Turn the power on, and set the camera to the **PLAYBACK** mode (☞ page 14).

**2** .....  
Press ◀ or ▶ to select the image you want to resize.

**3** .....  
Open the menu.  
• Press the **MENU** button, then use the four-way control to select **Resize** (☞) and press the **SET** button.



**4** .....  
Press ▲ or ▼ to select an option, and then press the **SET** button.  
• The resized image will be saved as a new file.

#### ! Caution



- Only a large size image can be resize to a smaller one.

### Changing the Image with Effects

You may use Red Eye Removal remove the red eye caused by flash from original photo. Or use color filters to save as a new image.

- 1 .....  
**Turn the power on, and set the camera to the PLAYBACK mode**  
( page 14).
- 2 .....  
**Press ◀ or ▶ to select the image you want to add the effect.**
- 3 .....  
**Open the menu.**
  - Press the **MENU** button, then use the four-way control to select **Photo Edit** () and press the **SET** button.
- 4 .....  
**Press ▲ or ▼ to select an option, and then press the SET button.**
  - The edited image will be saved as a new file.

### Choosing the Image with Photo Frame

- 1 .....  
**Turn the power on, and set the camera to the PLAYBACK mode**  
( page 14).
- 2 .....  
**Press ◀ or ▶ to select the image you want to add the photo frame.**
- 3 .....  
**Open the menu.**
  - Press the **MENU** button, then use the four-way control to select **Photo Frames** () and press the **SET** button.
- 4 .....  
**Press ▲ or ▼ to select the image you want, then press the SET button to apply the choice.**
  - The edited image will be saved as a new file.

## Copying the Files

You may copy the data from the camera's internal memory to the memory card for convenience.

**1** Be sure you have inserted a memory card into your digital camera. Set the camera to the **PLAYBACK** mode. (☞ page 14).

**2** Open the menu.

- Press the **MENU** button, then use the four-way control to select **Copy to card** (🔧) and press the **SET** button.

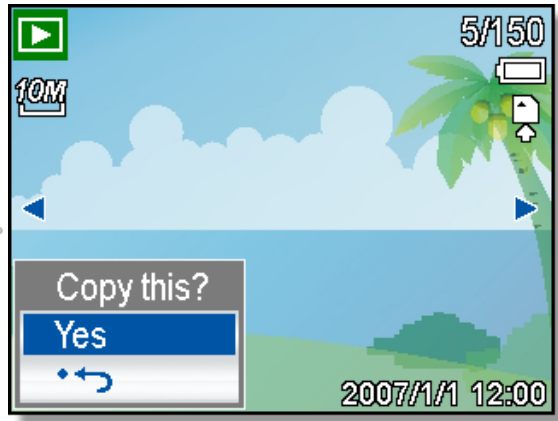

**3** Press ▲ or ▼ to select **[Single]**, then press the **SET** button.

- To copy all images to a memory card, select **[All]**.

**4** Press ◀ or ▶ to select the image you want to copy to a card.

**5** Select **[Yes]** and then press the **SET** button to start copy.

- Repeat step 4~5 to copy other images.
- Press the **MENU** button to complete the setting.

## Setting the DPOF

The Digital Print Order Format (DPOF) setting allows you to select images on the memory card for printing and specify the number of print copies in advance using the camera. This is extremely convenient for sending the images to a photo developing service or for printing on a direct print function compatible printer.

**1** Turn the power on, and set the camera to the **PLAYBACK** mode (page 14).

**2** Open the menu.

- Press the **MENU** button, then use the four-way control to select **DPOF** and press the **SET** button.

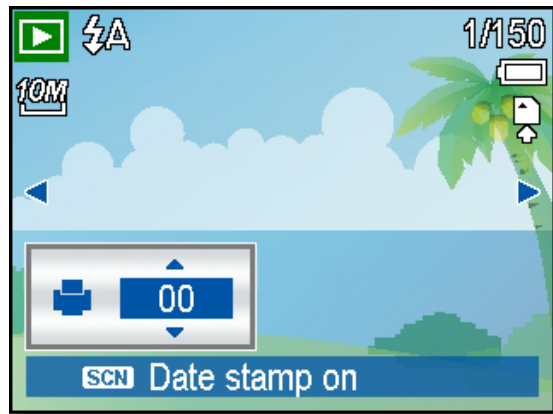

**3** Press **▲** or **▼** to select **[Single]**, then press the **SET** button.

- To set the DPOF setting for all images, select **[All]** in this step.
- To reset all DPOF settings to initial default, select **[Reset]** in this step.

**4** Press **◀** or **▶** to select the image you want to print out.

**5** Set the number of copies.

- Press **▲** or **▼** to specify the number of copies.
- The number of copies can be set from 0 to 30.
- To cancel this image DPOF setting, set the number of copies to 0.

**6** Print the date stamp out.

- Press **SCN** button to set the date stamp of current image. Press **SCN** button again to turn off date stamp.
- Repeat step 4~6 to other images for printing.

**7** After you finished all image settings, press the **SET** or **MENU** button to apply it.



## Choosing a Startup Image

- 1 .....  
Turn the power on, and set the camera to the **PLAYBACK** mode (👉 page 14).
- 2 .....  
Open the menu.
  - Press the **MENU** button, then use the four-way control to select **Start-up Image** (📷) and press the **SET** button.
- 3 .....  
Press ◀ or ▶ to select the image you want, then press the **SET** button to apply the choice.
  - A message “Completed” appears.
- 4 .....  
Set the camera to the **Setup Menu** (👉 page 18).
- 5 .....  
Press ▲ or ▼ to select **Start-up Image** (📷) then press ▶ or the **SET** button.
- 6 .....  
Press ▲ or ▼ to select a desired option and press the **SET** button to apply the setting.
  - [Off]: Disable the start-up image.
  - [System]: Use camera default image.
  - [My image]: Use the image that you just specified in step 3.
- 7 .....  
Press the **MENU** button to close the menu.

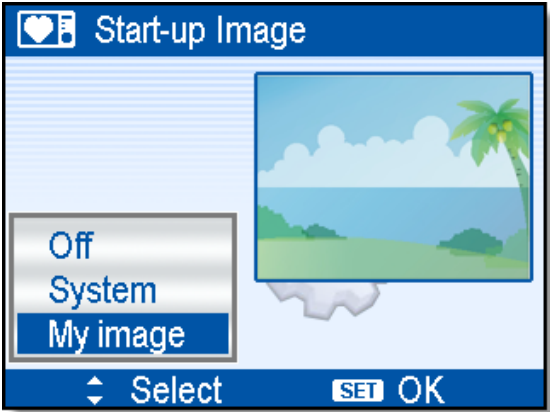

### ! Caution

- The start-up image will not be deleted even if the original image is deleted or memory formatted.

# Making Connections

## Connecting the Camera to a TV

You can display recorded images on a television with a supplied AV cable.

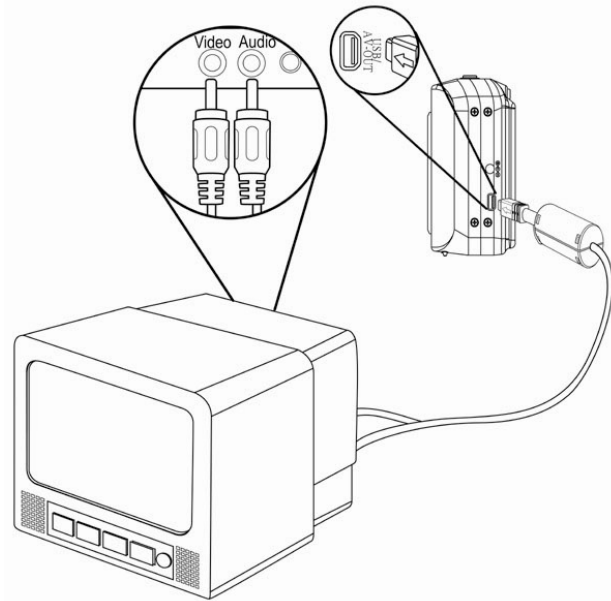

- 1** .....  
Set the TV out to match the TV system that you are using (👉 page 20).
- 2** .....  
Turn off the camera and the TV.
- 3** .....  
Use the supplied AV cable to connect the camera to the TV set.
- 4** .....  
Set the TV input signal to Video In.
  - Refer to the documentation included with your TV for more information.
- 5** .....  
Display on TV.
  - Everything that would normally appear on the camera's LCD screen, such as photo and video clip playback, slide shows, and image or video capture, appears on the TV.

## Connecting the Camera to a PC

There are two ways to download files from the camera's internal memory or memory card to a computer:

- Inserting the memory card into a card reader
- Connecting the camera to a computer using the supplied USB cable

### Using the Card Reader

**1** Eject the memory card from the camera and insert it in a card reader that is connected to a computer.

**2** Open [My Computer] or [Windows Explorer] and double-click the removable drive icon that represents the memory card.

**3** Copy images from the card into a directory of your choice on the computer's hard disk.

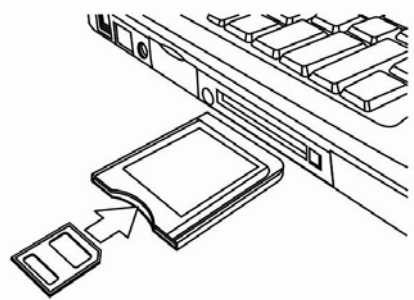

### Connecting the Camera to a Computer with the USB Cable

**1** Install the USB software driver included with the bundled CD-ROM.

**2** Connect the supplied USB cable to the computer's USB port and turn on the camera.

- The LCD screen turns off when the connection to the computer has been successfully completed.

**3** Open [My Computer] or [Windows Explorer]. A "Removable Disk" appears in the drive list.

**4** Double-click the "Removable Disk" icon to view its contents.

- Files stored on camera are located in the folder name "DCIM".

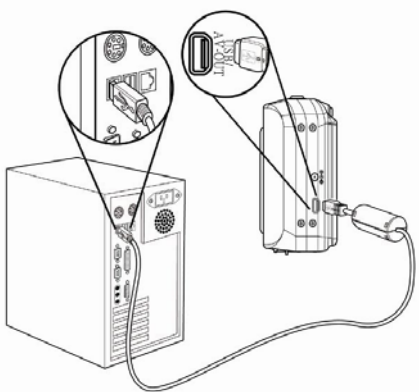

# Appendix

## About the Folder & File Name

Your digital camera automatically creates a directory of folders in the internal memory or memory card that it uses to organize still images, movie clips and other information.

### Folder Structure

Your camera creates three directory names:

- **DICAM.** All captured images, videos and audio files are stored in this folder except for files recorded using the Auction or YouTube® mode.
- **\_AUCT.** Captured images using the Auction mode are saved in this folder.
- **\_UTUBE.** Captured videos using the YouTube mode are saved in this folder.

Folder name begins with a 3-digit number from 100 to 999 and followed by “DICAM” or “\_AUCT” or “UTUBE”, each folder holds up to 9999 files. If new files are made, a new folder named in sequence will be made automatically.

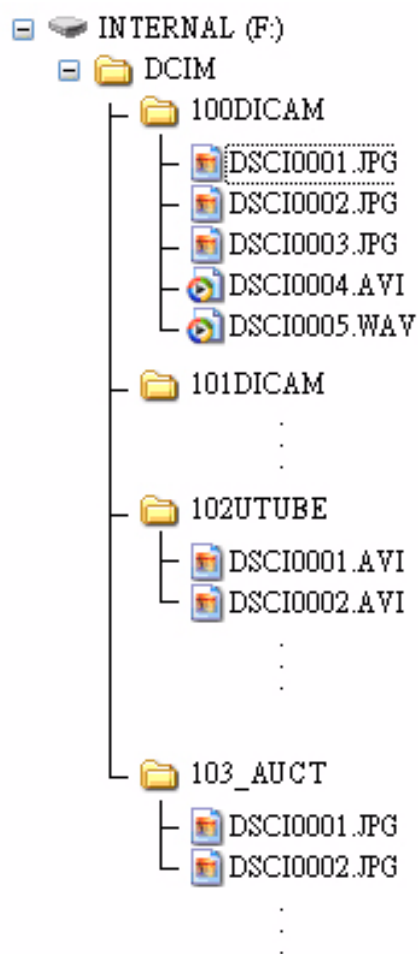

## File Naming

File name begins with “DSCI” and are followed by a 4-digit number that increases in sequence. File numbering starts from 0001 when a new folder is created.

If the highest folder number is 999 and highest file number exceeds 9999, the camera will display the warning message “Folder cannot be created”. When it appears, try one of the following ways:

- Reset the file number and plug in a new memory card.
- The folder number and file number are initialized and renumbered from 100 and 0001 respectively.



### Caution

---

- Do not change the folder and file names in the memory card using your computer. It may be unable to playback the data using the digital camera.

## Troubleshooting

Problem	Cause	Solution
Power does not turn on.	Battery is inserted in the wrong direction.	Reload battery in the correct direction.
	Batteries are dead.	Replace or recharge batteries.
	The battery compartment door is open.	Make sure the battery compartment door is securely closed.
The camera does not take pictures.	The flash is charging.	Wait for the flash to charge.
	Memory is full.	Insert a new memory card.
	Memory card is not formatted correctly.	The card may be defective, use a new card.
Image is not recorded when the shutter button is pressed.	The Flash is charge.	Wait for the flash to charge.
	Memory is full.	Insert a new memory card.
The flash does not fire.	Flash is set to OFF.	Set the flash to any mode except off.
Image is blurry or out of focus.	The camera was moving when the image was captured.	Hold the camera steady when shooting picture.
	The subject was beyond the range within which the camera can focus.	Turn the Macro mode on if the subject is within 15 cm or 40 cm. Do not use Macro mode when shooting distant subjects.
Image is not displayed on the LCD monitor.	A memory card with non-DCIF images (recorded with other camera) is loaded.	This camera cannot display non-DCIF images.
Recorded images are not saved in memory.	The camera was turned off / powered down before the image was stored in memory.	If the battery low indicator appears on the LCD monitor, replace the battery immediately.
Cannot transfer images to a computer after connecting the USB cable.	USB driver is not installed.	Install the USB driver before you connect the camera to a computer / turn the camera on.
Card error	The memory card format may not be correct.	Re-format the memory card to the FAT format using a card reader in Windows.
The lens got stuck up.	The type of the battery used may be incorrect or the battery power level is too low.	Do not force the lens to go back. Change the battery or charge the battery before using the camera.

## Specifications

Sensor	10 megapixel CCD, Size : 1/2.3 inch
Lens	Focal length: f = 6.2 ( W ) ~ 18.6 ( T ) mm , 3X optical zoom, 4X digital zoom
LCD Display	2.7" LCD
Focus Range	Normal: (W) 15 cm ~ Infinity / (T) 40 cm ~ Infinity Macro: (W) 15 cm ~ 1 m / (T) 40 cm ~ 1 m
Aperture	F/ 2.8 ( W ), 5.1 ( T )
Shutter	8 ~ 1/2000 sec.
File Format	Still Image: EXIF 2.2 compatible format (JPEG compression), DCF compatible; Support DPOF; Video: AVI , Audio: WAV
Resolution	Still Image: 3648 x 2736 (10M) / 3648 x 2432 (3:2) / 3648 x 2048 (16:9) / 3264 x 2448 (8M) / 2560 x 1920 (5M) / 2048 x 1536 (3M) / 640 x 480 (VGA); Video: 720 x 400 / 640 x 480 / 320 x 240
Scene Mode	Program / Movie / Voice REC / Q. Mode / Portrait / Landscape / Sunset / Backlight / Smile Capture / Kids / Night scene / Fireworks / Snow / Sports / Party / Candlelight / Night Portrait / Soft Skin / Soft Flowing Water / Food / Building / Text / Auction / Blink Detection
Sensitivity	Auto / ISO 100 / ISO 200 / ISO 400 / ISO 800 / ISO 1600 / ISO 3200
White Balance	Auto / Daylight / Cloudy / Tungsten / Fluorescent (H) / Fluorescent (L) / Custom
Exposure Control	-2EV to +2EV in 1/3 step
Metering	Center-weighted / Multi / Spot
Drive mode	2 sec. / 10 sec. / Double / Burst
Flash	Auto / Red eye reduction / Always on / Slow sync / Always off
Photo Edit	Red eye removal / Black & White / Sepia / Negative / Mosaic / Red / Green / Blue
Storage	16 MB internal memory / SD Card (2 GB)/ SDHC (16 GB)
TV system	NTSC / PAL
Power Supply	Rechargeable Lithium-ion Battery (Li-Ion 820 mAh)
Ambient temperature	Operating: 0° C to 50° C Storage: -20 to 60° C
Microphone	Built-in
Speaker	Built-in
Dimension	Camera Body ( W x H x T ): 91.3 x 56.55 x 23 mm
Weight	Camera Body w/o battery: Approx. 120 (g)

\*These specifications are subject to change without notice.









Mode	Still Capture													
	Scene Mode													
Function	MENU													
	Auto	Daylight	Cloudy	Tungsten	Fluor_H	Fluor_L	Shutter	Auto	100	200	400	800	1600	3200
	x	x	x	x	x	x	x	x	x	x	x	x	x	x
	●	○	○	○	○	○	○	x	x	x	x	x	x	x
	●	x	x	x	x	x	x	●	x	x	x	x	x	x
	●	x	x	x	x	x	x	●	x	x	x	x	x	x
	●	x	x	x	x	x	x	●	x	x	x	x	x	x
	●	x	x	x	x	x	x	●	x	x	x	x	x	x
	●	x	x	x	x	x	x	●	x	x	x	x	x	x
	●	x	x	x	x	x	x	●	x	x	x	x	x	x
	●	x	x	x	x	x	x	●	x	x	x	x	x	x
	●	x	x	x	x	x	x	●	x	x	x	x	x	x
	●	x	x	x	x	x	x	●	x	x	x	x	x	x
	●	x	x	x	x	x	x	●	x	x	x	x	x	x
	●	x	x	x	x	x	x	●	x	x	x	x	x	x
	●	x	x	x	x	x	x	●	x	x	x	x	x	x
	●	x	x	x	x	x	x	●	x	x	x	x	x	x
	●	x	x	x	x	x	x	●	x	x	x	x	x	x
	●	x	x	x	x	x	x	●	x	x	x	x	x	x
	○	○	○	○	○	○	○	x	○	●	○	○	○	○
	○	○	○	○	○	○	○	○	○	○	○	○	○	○
	○	○	○	○	○	○	○	○	○	○	○	○	○	○
	◇	○	○	○	○	○	○	◇	○	○	○	○	○	○

Mode	Still Capture													
	Scene Mode													
Function	MENU													
	Portrait	Portrait II	Portrait III	Portrait IV	Portrait V	Portrait VI	Portrait VII	Portrait VIII	Portrait IX	Portrait X	Portrait XI	Portrait XII	Portrait XIII	Portrait XIV
+0.3 ~ +2.0	x	x	x	x	x	x	x	x	x	x	x	x	x	x
0EV	x	x	x	x	x	x	x	x	x	x	x	x	x	x
-0.3 ~ -2.0	x	●	x	●	○	○	x	x	●	x	●	x	x	x
Off	x	●	x	○	○	○	○	○	●	x	●	x	x	x
2 sec.	x	●	x	○	○	○	○	○	●	x	●	x	x	x
10 sec.	x	●	x	○	○	○	○	○	●	x	●	x	x	x
Double	x	●	x	○	○	○	○	○	●	x	●	x	x	x
Burst	x	●	x	○	○	○	○	○	●	x	●	x	x	x
Off	x	●	x	○	○	○	○	○	●	x	●	x	x	x
On	x	●	x	○	○	○	○	○	●	x	●	x	x	x
Off	x	●	x	○	○	○	○	○	●	x	●	x	x	x
	x	●	x	○	○	○	○	○	●	x	●	x	x	x
	x	●	x	○	○	○	○	○	●	x	●	x	x	x
	x	●	x	○	○	○	○	○	●	x	●	x	x	x
	x	x	x	○	○	○	○	○	●	x	○	○	○	○
	○	○	○	○	○	○	○	○	●	○	○	○	○	○
	○	○	○	○	○	○	○	○	●	○	○	○	○	○
	○	◆	○	◆	○	○	○	○	●	○	◆	○	○	○
Exposure														
Drive Mode														
AEB														
Highlight														

Mode	Still Capture														
	Scene Mode														
Function	MENU														
	Hard	Normal	Soft	Off	B&W	Sepia	Negative	Red	Green	Blue	Off	Date	Date & Time	Off	On
Sharpness	x	x	x	x	x	x	x	x	x	x	x	x	x	x	x
Effect	x	x	x	x	x	x	x	x	x	x	x	x	x	x	x
	x	●	x	●	○	○	x	○	x	x	○	○	○	○	○
	x	●	x	●	○	○	○	○	○	○	○	○	○	○	○
	●	x	x	●	○	○	○	○	○	○	○	○	○	○	○
	●	x	x	●	○	○	○	○	○	○	○	○	○	○	○
	x	●	x	●	○	○	○	○	○	○	○	○	○	○	○
	x	x	x	●	○	○	○	○	○	○	○	○	○	○	○
	x	●	x	●	○	○	x	○	x	x	○	○	○	●	x
	x	●	x	●	○	○	○	○	○	○	○	○	○	●	x
	x	●	x	●	○	○	○	○	○	○	○	○	○	○	○
	x	●	x	●	○	○	○	○	○	○	○	○	○	○	○
	x	●	x	●	○	○	○	○	○	○	○	○	○	○	○
	x	x	●	●	○	○	○	○	○	○	○	○	○	○	○
	x	●	x	●	○	○	x	○	x	x	○	○	○	○	○
	x	●	x	●	○	○	x	○	x	x	x	x	●	○	○
○	○	○	○	○	○	○	○	○	○	○	○	○	○	●	x
○	○	○	○	○	○	○	○	○	○	○	○	○	○	●	x
○	○	○	○	○	○	○	○	○	○	○	○	○	○	●	x
○	◇	○	◇	○	○	○	○	○	○	○	◇	○	○	◇	○
Date Stamp															
Stabilizer															



## Customer care

More information on the complete AgfaPhoto digital camera product range can be found under [www.plawa.com](http://www.plawa.com) / [www.plawausa.com](http://www.plawausa.com)

To return a product, you will need an RMA number which must be clearly visible on the returned shipment. You can find further information on the return of goods either by phoning our Support Hotlines or via the plawa website under the Menu item "Service & Support".

### **Service & Repair (USA/ Canada):**

1-866 475 2605

[www.plawausa.com](http://www.plawausa.com)

### **Service & Repair Hotline (EU):**

00800 752 921 00 (from a landline only)

### **Service & Support Hotline (Germany):**

0900 1000 042 (1.49 Euro/ min. from a German landline only)

### **Online Service / International contact:**

[support-apdc@plawa.com](mailto:support-apdc@plawa.com)

Manufactured by

plawa-feinwerktechnik GmbH & Co. KG

Bleichereistraße 18

73066 Uhingen

Germany

AgfaPhoto is used under license of Agfa-Gevaert NV & Co. KG. Agfa-Gevaert NV & Co. KG. does not manufacture this product or provide any product warranty or support. For service, support and warranty information, contact the distributor or manufacturer.

Contact: AgfaPhoto Holding GmbH, [www.agfaphoto.com](http://www.agfaphoto.com)



## Copyright

This manual contains proprietary information protected by copyright. All rights are reserved. No part of this manual may be reproduced by any mechanical, electronic or other means, in any form, without prior written permission of the manufacturer. © Copyright 2008.

## Trademark Recognition

Windows 98, 2000, ME, XP are registered trademarks of Microsoft Corporation in the United States and/or other countries. Windows is an abbreviated term referring to the Microsoft Windows Operation System. All other companies or product names are trademarks or registered trademarks of their respective companies. YouTube is a brand of Google, Inc. and YouTube, LLC, Mountain View, California, US.

## Disposal of Waste Equipment by Users in Private Households in the European Union



This symbol on the product or on its packaging indicates that this product must not be disposed of with your other household waste. Instead, it is your responsibility to dispose of your waste equipment by handing it over to a designated collection point for the recycling of waste electrical and electronic equipment. The separate collection and recycling of your waste equipment at the time of disposal will help to conserve natural resources and ensure that it is recycled in a manner that protects human health and the environment. For more information about where you can drop off your waste equipment for recycling, please contact your local city office, your household waste disposal service or the shop where you purchased the product.

## FCC Compliance and Advisory

This device complies with Part 15 of the FCC Rules. Operation is subject to the following two conditions: 1.) this device may not cause harmful interference, and 2.) this device must accept any interference received, including interference that may cause unsatisfactory operation. This equipment has been tested and found to comply with the limits for a Class B peripheral, pursuant to Part 15 of the FCC Rules. These limits are designed to provide reasonable protection against harmful interference in a residential installation. This equipment generates, uses, and can radiate radio frequency energy and, if not installed and used in accordance with

the instructions, may cause harmful interference to radio communication. However, there is no guarantee that interference will not occur in a particular installation. If this equipment does cause harmful interference to radio or television reception, which can be determined by turning the equipment off and on, the user is encouraged to try to correct the interference by one or more of the following measures.

- Reorient or relocate the receiving antenna.
- Increase the separation between the equipment and receiver.
- Connect the equipment to an outlet on a circuit different from that to which the receiver is connected.
- Consult the dealer or an experienced radio/TV technician for help.

Any changes or modifications not expressly approved by the party responsible for compliance could void the user's authority to operate the equipment. When shielded interface cables have been provided with the product or when specified additional components or accessories have elsewhere been designated to be used with the installation of the product, they must be used in order to ensure compliance with FCC regulations.